

Acti 9

Advanced Communication

Technology that Inspires.....



Leading Future....

>Innovative >Efficient >Reliable

Schneider
Electric

About Schneider Electric

About Schneider Electric

As a global specialist in energy management, Schneider Electric offers integrated solutions across multiple market segments, including leadership positions in energy and infrastructure, industrial processes, building automation, and data centres/networks, as well as a broad presence in residential applications.

Focused on making energy safe, reliable, and efficient, the Company is committed to help individuals and organizations "Make the most of their energy".



Our presence worldwide and in India

Schneider Electric Worldwide

22.4
billion sales in 2011



394
Rank in Fortune 500 ranking



39
% of sales in new economies



4-5%
Revenue devoted to R&D



130000 +
people in 100+ countries



Schneider Electric in India*

17000 +
employees



31
Global Manufacturing Plants



10 +
Distribution Centres



1000 +
R&D engineers in Bangalore



1
Regional Project & Engineering Centre



*Figures as on April 2012

Acti 9

Advanced Communication

Technology that Inspires.....

Total Communication from
POWER to **FINAL Distribution**



1995
Masterpact NT/NW
ACBs



2005
Compact NSX
MCCBs



2012

>Acti 9

MCBs, RCDs, DBs



Acti 9 | Advanced Communication Technology that Inspires

> Protection devices

- Miniature circuit breaker
- Residual current circuit breaker
- Vigi™ residual current devices
- Surge arrester

> Protection monitoring and supervision

- Indication and tripping auxiliaries
- Remote control auxiliaries
- Automatic recloser auxiliaries



Innovative

Protection monitoring, Total control and Metering @ DB level



Efficient

Manage loads, reduce operating and project costs, and accurately plan maintenance

> Control and monitoring

- Contactors
- Impulse relays
- Integrated control circuit breaker
- Light indicators
- Push-buttons and selector switches
- Kilowatt hour meters
- Communicating architecture

> Installation system

- Installation system
- IP20B terminals
- Splitter block
- Full range of mounting and wiring accessories



Reliable

Dual certifications for one product, 100 percent MCB and RCD Coordination, easy ordering and design, error free fast connections

5 generations

of industry experience make Acti 9 the new reference in low-voltage modular systems

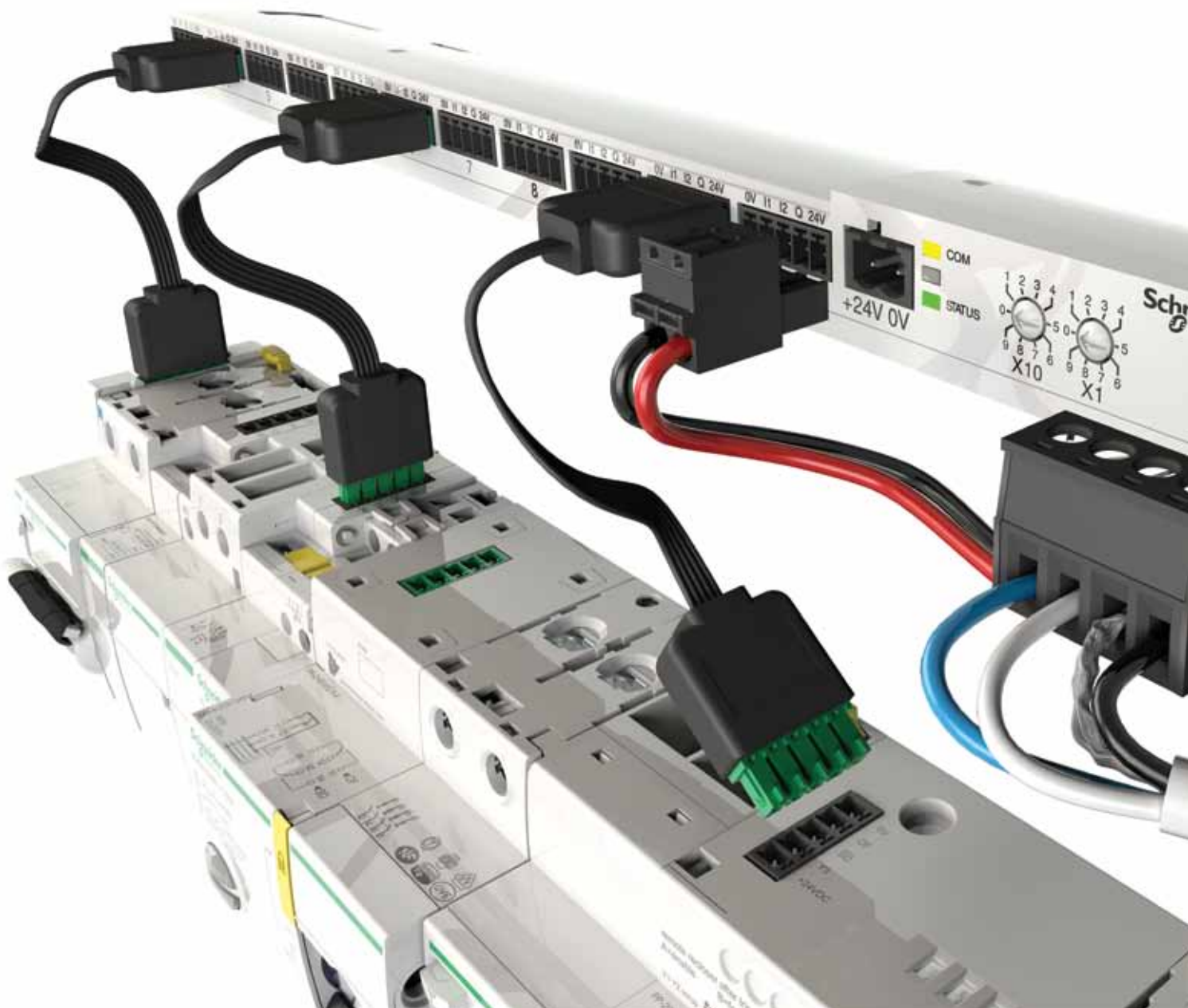

Contents

Protection Devices	3-20
MCBs	3
RCDs	9
SPDs	15
Auxiliaries	19
<hr/>	
Control & Indication Devices	21-35
Communication Ready Devices	22-29
Reflex iC60	24
iCT Contactors	25
iTL Impluse Relays	26
Smartlink	27
Energy Meters	28
Auxiliaries and Accessories	29
Basic Control & Indication Devices	30-35
Isolators	30
Changeover Switches	31
Push buttons	32
Indicators	33
Bells and Buzzers	34
Time Switches	35
<hr/>	
Technical Information	36-63
Dimensions	36
Complimentary Technical Information	41
Protection Discrimination	53
Cascading	59
<hr/>	
Applications	65-68

New
range of MCBs,
RCDs and DBs



Global range for Indian Installations

- > **MCBs suitable for higher ambient temperature**
 - No De-rating required till 50°C
- > **SI version RCDs now also suitable for adverse environmental conditions**
 - Assured protection in electrically polluted networks
 - Enhanced protection in corrosive and humid environment
- > **Widest product range for every application**
 - MCBs from 0.5A to 125A with 10kA to 50kA breaking capacity
 - RCDs upto 125A with 10mA – 1000mA sensitivity
 - SPDs, Auxiliaries and accessories, Control and Indication devices



Green Products

100% Recyclable
and Recoverable
REACH and RoHS
compliant

Protection Devices

Miniature Circuit Breakers (MCBs)



- > Protection against Overload and Short Circuit current fault
- > Protection of people against indirect contact in IT and TN earthing systems
- > Suitability for isolation in the industrial sector to IEC/EN 60947-2

Key Benefits

- Widest range: Precise solution for all application
 - > 0.5A to 125A
 - > High breaking capacity range - from 10kA to 50kA
- Low cost with higher performance: Cascading
Cascading charts available From ACB-MCCB-MCB level
- Reduce Downtime: Discrimination
Discrimination charts available From ACB-MCCB-MCB level
- Easy Installation: Bi – connect terminals
- Increased service life: Fast Closing mechanism
- Field fittable auxiliaries available for advance protection and monitoring
- Field fittable Comm ready auxiliary for remote monitoring of:
 - Status of MCB - ON / OFF / Trip
 - Number of ON / OFF operations
 - Number of tripping due to faults
 - Number of running hours



Green Products

100% Recyclable and Recoverable
REACH and RoHS compliant

Suitable for

ComReady Auxiliary



Protection Devices

Miniature Circuit Breakers (MCBs)

xC60

10kA - IS/IEC 60898-1; IEC/EN 60898-1

15kA - IEC 60947-2





Key Features

- Ensures no accidental contact with live part - Finger-proof IP-20 terminals
- Operational Safety at the downstream - Suitability for Isolation
- Avoids false insertion of cables and loose termination : Pull up terminals
- Total Flexibility : Line-Load reversibility
- Field fittable auxiliaries available for advanced protection & monitoring
- Flexible termination of Busbars and Cables - Bi-Connect terminals
- Suitable for DC application (60VDC/pole)
- Breaking Capacity enhanced to 25kA as per IEC 60947 when backed by Compact NSX MCCBs

Technical Data

Parameter	xC60 MCB
Current Rating	0.5-63A
Poles	1,2,3,4
Rated Voltage	240-415V
Terminal Capacity	Rigid cables upto 35 sqmm Flexible cables upto 25 sqmm
Impulse Withstand Voltage	6KV
Breaking Capacity	10KA as per IEC-60898-1 15KA as per IEC-60947-2
Limitation Class	3
Operating Temperature	-25 to 70°C



MCB xC60					
Poles	Rating (A)	References			Module Width
		B Curve	C Curve	D Curve	
 	0.5	-	A9N1PD5C	-	1
	1	-	A9N1P01C	A9N1P01D	1
	2	-	A9N1P02C	A9N1P02D	1
	3	-	A9N1P03C	A9N1P03D	1
	4	-	A9N1P04C	A9N1P04D	1
	6	A9N1P06B	A9N1P06C	A9N1P06D	1
	10	A9N1P10B	A9N1P10C	A9N1P10D	1
	16	A9N1P16B	A9N1P16C	A9N1P16D	1
	20	A9N1P20B	A9N1P20C	A9N1P20D	1
	25	A9N1P25B	A9N1P25C	A9N1P25D	1
	32	A9N1P32B	A9N1P32C	A9N1P32D	1
	40	A9N1P40B	A9N1P40C	A9N1P40D	1
	50	A9N1P50B	A9N1P50C	A9N1P50D	1
	63	A9N1P63B	A9N1P63C	A9N1P63D	1
 	0.5	-	A9N2PD5C	-	2
	1	-	A9N2P01C	A9N2P01D	2
	2	-	A9N2P02C	A9N2P02D	2
	3	-	A9N2P03C	A9N2P03D	2
	4	-	A9N2P04C	A9N2P04D	2
	6	A9N2P06B	A9N2P06C	A9N2P06D	2
	10	A9N2P10B	A9N2P10C	A9N2P10D	2
	16	A9N2P16B	A9N2P16C	A9N2P16D	2
	20	A9N2P20B	A9N2P20C	A9N2P20D	2
	25	A9N2P25B	A9N2P25C	A9N2P25D	2
	32	A9N2P32B	A9N2P32C	A9N2P32D	2
	40	A9N2P40B	A9N2P40C	A9N2P40D	2
	50	A9N2P50B	A9N2P50C	A9N2P50D	2
	63	A9N2P63B	A9N2P63C	A9N2P63D	2
 	0.5	-	A9N3PD5C	-	3
	1	-	A9N3P01C	A9N3P01D	3
	2	-	A9N3P02C	A9N3P02D	3
	3	-	A9N3P03C	A9N3P03D	3
	4	-	A9N3P04C	A9N3P04D	3
	6	A9N3P06B	A9N3P06C	A9N3P06D	3
	10	A9N3P10B	A9N3P10C	A9N3P10D	3
	16	A9N3P16B	A9N3P16C	A9N3P16D	3
	20	A9N3P20B	A9N3P20C	A9N3P20D	3
	25	A9N3P25B	A9N3P25C	A9N3P25D	3
	32	A9N3P32B	A9N3P32C	A9N3P32D	3
	40	A9N3P40B	A9N3P40C	A9N3P40D	3
	50	A9N3P50B	A9N3P50C	A9N3P50D	3
	63	A9N3P63B	A9N3P63C	A9N3P63D	3
 	0.5	-	A9N4PD5C	-	4
	1	-	A9N4P01C	-	4
	2	-	A9N4P02C	A9N4P02D	4
	3	-	A9N4P03C	A9N4P03D	4
	4	-	A9N4P04C	A9N4P04D	4
	6	A9N4P06B	A9N4P06C	A9N4P06D	4
	10	A9N4P10B	A9N4P10C	A9N4P10D	4
	16	A9N4P16B	A9N4P16C	A9N4P16D	4
	20	A9N4P20B	A9N4P20C	A9N4P20D	4
	25	A9N4P25B	A9N4P25C	A9N4P25D	4
	32	A9N4P32B	A9N4P32C	A9N4P32D	4
	40	A9N4P40B	A9N4P40C	A9N4P40D	4
	50	A9N4P50B	A9N4P50C	A9N4P50D	4
	63	A9N4P63B	A9N4P63C	A9N4P63D	4

**Module width - 18mm/Module

Protection Devices

Miniature Circuit Breakers (MCBs)

C120

10kA & 15kA

IEC/EN-60898-1, IEC 60947-2





Key Features

- C120N/H are higher rating MCBs for Overload and short-circuit protection
- Ensures no accidental contact with live part - Finger-proof IP-20 terminals
- Avoids false insertion of cables and loose termination : Pull up terminals
- Total Flexibility : Line-Load reversibility
- Operational Safety at the downstream - Suitability for Isolation
- Field fittable auxiliaries available for advanced protection
- Longer product service life : Good overvoltage withstand capacity: products designed to offer a high industrial performance level

Technical Data

Parameter	C120N	C120H
Current Rating	80,100,125	80,100,125A
No. of Poles	1,2,3,4	1,2,3,4
Rated Voltage	240/415V	240/415V
Terminal Capacity	Rigid upto 50 sqmm Flexible upto 35 sqmm	Rigid upto 50 sqmm Flexible upto 35 sqmm
Impulse Withstand Voltage	6KV	6KV
Breaking Capacity	10KA as per IEC 60898-1	15KA per IEC 60898-1
Energy limiting class	3	3
Operating Temperature	-30 to 70°C	-30 to 70°C

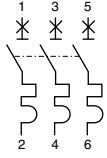

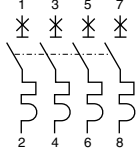
MCB C120				
Poles	Rating (A)	C120N	C120H	Module Width
		References C Curve		
1P  	80	A9N18357	A9N18446	1.5
	100	A9N18358	A9N18447	1.5
	125	A9N18359	A9N18448	1.5
2P  	80	A9N18361	A9N18457	3
	100	A9N18362	A9N18458	3
	125	A9N18363	A9N18459	3
3P  	80	A9N18365	A9N18468	4.5
	100	A9N18367	A9N18469	4.5
	125	A9N18369	A9N18470	4.5
4P  	80	A9N18372	A9N18479	6
	100	A9N18374	A9N18480	6
	125	A9N18376	A9N18481	6

**Module width - 18mm/Module

NG125N (25kA) MCB



(NG125N 4P)

Current Rating	10-125A
Poles	1/2/3/4P
Rated Voltage	240/415V
Tripping Curves	B,C,D
Thermal Tripping	40°C
Breaking Capacity	25KA
Degree of Pollution	3
Operating Temperature	-30 to +70°C
Standard	IEC/EN 60947-2

NG125H (36kA) MCB



(NG125H 4P)

Current Rating	10-80A
Poles	1,2,3,4 P
Rated Voltage	240/415V
Tripping Curves	C
Thermal Tripping	40°C
Breaking Capacity	36KA
Degree of Pollution	3
Operating Temperature	-30 to +70°C
Standard	IEC/EN 60947-2

NG125L(50kA) MCB



Current Rating	10-80A
Poles	1,2,3,4P
Rated Voltage	240/415V
Tripping Curves	B,C,D
Thermal Tripping	40°C
Breaking Capacity	50KA
Degree of Pollution	3
Operating Temperature	-30 to +70°C
Standard	IEC/EN 60947-2

UL MCB



	UL_1077 MCB	UL_489 MCB
Type	UL_1077 MCB	UL_489 MCB
Poles	1,2,3,4	1,2,3
Tripping Curves	B,C	C
Voltage Rating	240/415	240/415V
Breaking Capacity	10kA	10kA
Degree of Pollution	3	3
Operating Temperature	(-30 to 70°C)	(-30 to 70°C)
Standard	IEC 60947-2/UL 1077/CSA	IEC 60947-2/ UL 489

C60NA-DC



Operating voltage (Ue)	20 A: 650 V DC
	30 A: 500 V DC
	40 A: 400 V DC
	50 A: 300 V DC
Rated insulation voltage (Ui)	1,000 V DC
Rated operational current (Ie)	50A
Impulse voltage (Uimp)	6kV
Number of poles	2P
Standards	IEC/EN 60947-3

** For more details Please contact Schneider-Electric Customer Care Centre (Email: customercare.in@schneider-electric.com)



New
range of MCBs,
RCDs and DBs

Build your Installation Efficiently

- > **Cost Efficient**
 - Upto 40%* reduction in Control & Power wiring
 - Upto 25% savings on Installation cost by replacing conventional electrical panels by Distribution Boards
- > **Time Efficient**
 - Upto 15%* time savings on Design and Installation by using smart connections with pre-fabricated wiring
- > **Space Efficient**
 - Upto 35%* reduction in space utilization by using modular FD range



Green Products

100% Recyclable
and Recoverable
REACH and RoHS
compliant

* Over conventional communication system

Protection Devices

Residual Current Devices (RCDs)



For Effective Protection against

- > Electrocutation due to Direct and Indirect Contact & Earth leakages
- > Personal Protection - 30mA
- > Fire Protection - 100mA & 300mA

Key Benefits

- Widest range: Precise solution for all application
 - > Rating up to 125A
- Easy monitoring: Earth fault indication on front face
- Immunity against nuisance tripping
- **New SI RCDs** offers enhanced immunity to electrical disturbances and polluted & corrosive environments
- Easy Installation: bi-connect terminals
- Field fittable auxiliaries for advanced protection & monitoring
- Field fittable Comm ready auxiliary for remote monitoring of:
 - Status of RCD - ON / OFF / Trip
 - Number of ON / OFF operations
 - Number of tripping due to faults
 - Number of running hours



Green Products

100% Recyclable and Recoverable
REACH and RoHS compliant

Suitable for

ComReady Auxiliary



Protection Devices

Residual Current Devices (RCDs)

xID & ID 125 RCCBs

IEC/EN 61008-1, IS-12640-1



Key Features

- Current Rating upto 125A
- **Class AC** - for normal installation
- **Class Si** - for electrically disturbed networks (with harmonics, pulsating DC components etc.) & for harsh environments (presence of corrosive atmosphere chemical gases etc)
- Front face trip on fault indication
- Finger-proof IP-20 terminals - ensures no accidental contact with live part
- Test button to check healthiness
- Intermediate auxiliary required for add-on protection and indication auxiliaries
- ID125 RCCBs are suitable for indication OFsp auxiliary only
- 4P RCCB is also suitable for 3phase 3 wire installation

Technical Data

Type	xID#	xID#	ID 125
Class	AC	Si	AC/Si
Current Rating	25-80A	25-63A	125A
Sensitivity	30/100/300mA	30/300mA	30/100/300mA
Poles	2,4	2,4	2,4
Rated Voltage	230-415V	230-415V	230-400V
Terminal Capacity	Rigid - 35 sqmm	Rigid - 35 sqmm	Rigid - 50 sqmm
	Flexible - 25 sqmm	Flexible - 25 sqmm	Flexible - 35 sqmm
Impulse Withstand Voltage	6KV	6KV	6KV
Operating Temperature	-5 to 40°C	-25 to 40°C	-5 to 40°C



RCDs						
xID & ID 125						
Poles	Type	Rating (A)	References			Module Width
			30mA	100mA	300mA	
2P						
	AC	25	A9N16201	-	A9N16202	2
		40	A9N16204	A9N16205	A9N16206	2
		63	A9N16208	A9N16209	A9N16210	2
		80	A9N16212	A9N16213	A9N16214	2
		125	16966	-	16967	2
	SI	25	A9N16234	-	-	2
		40	A9N16237	-	-	2
		63	A9N16240	-	A9N16246	2
		125	16972	-	16973	2
		4P				
	AC	25	A9N16251	-	A9N16252	4
		40	A9N16254	A9N16255	A9N16256	4
		63	A9N16258	A9N16259	A9N16260	4
		80	A9N16261	A9N16262	A9N16263	4
		125	16905	16906	16907	4
	SI	25	A9N16321	-	-	4
		40	A9N16324	-	-	4
		63	A9N16327	-	A9N16334	4
		125	16920	-	16921	4

*Contact Customer Care Centre for more details

Key Features

- Compact space saving design - 2Pole 2Module
- The DPN N Vigì residual current device provides complete protection for final circuits (against overcurrent and earth leakage faults)
The new SI RCCB offers perfect protection in installations disturbed by:
 - > extreme atmospheric conditions (humid, corrosive)
 - > any type of electrical impurity
- Avoids false insertion of cables and loose termination : Pull up terminals
- Immune to nuisance tripping due to Transient overvoltages

Technical Data

Type	AC	SI
Current Rating	6-40A	6-40A
Sensitivity	30/300mA	30/300mA
Poles	1P+N	1P+N
Curve	C	C
Rated Voltage	230-415V	230-415V
Terminal Capacity	Rigid upto 16 sq mm	Rigid upto 16 sq mm
	Flexible upto 10 sq mm	Flexible upto 10 sq mm
Impulse Withstand Voltage	4kV	4kV
Breaking Capacity	6kA	6kA
Limitation Class	3	3
Operating Temperature	-5 to 40°C	-25°C to +60°C



RCBO iDPN N Vigì					
Poles	Type	Rating (A)	References		Module Width
			30mA	300mA	
C Curve					
1P+N	AC	6A	A9N19661	A9N19681	2
		10A	A9N19663	A9N19683	2
		16A	A9N19665	A9N19685	2
		20A	A9N19666	A9N19686	2
		25A	A9N19667	A9N19687	2
		32A	A9N19668	A9N19688	2
	SI	40A	A9N19669	A9N19689	2
		6A	A9N19631	A9N19641	2
		10A	A9N19632	A9N19642	2
		16A	A9N19634	A9N19644	2
		20A	A9N19635	A9N19645	2
		25A	A9N19636	A9N19646	2
		32A	A9N19637	A9N19647	2
		40A	A9N19638	A9N19648	2

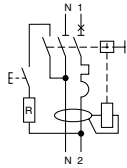

Protection Devices

Residual Current Devices (RCDs)

Vigi xC60 (add on RCD - AC Type)

IEC/EN 61009-1

30mA/300mA

Key Features

- Combined with xC60 circuit breaker, the Vigi xC60 provide: Protection against earth leakage, short circuit and Overload faults - add on block for xC60 MCB
- Fault tripping is indicated by a red mechanical indicator on the front face
- Combinations of Vigi xC60 + xC60 MCB - Flexibility to choose MCB (xC60 range) as per load requirement
- Field fittable auxiliaries available



Technical Data

	Vigi xC60	Vigi C120
Type	AC	AC/A/Si
Current Rating	25-63A	125A
Sensitivity	30/100/300mA	30/ 300/500/300 Δ /1000 mA Δ
Poles	2,4	2P,3P,4P
Rated Voltage	230-400V	230-415V
Terminal Capacity	Rigid - 25A - 25 sq mm 63A - 35 sq mm	Rigid - 50 sq mm
	Flexible - 25A - 16 sq mm 63A - 25 sq mm	Flexible - 35 sq mm
Impulse Withstand Voltage	6KV	6KV
Operating Temperature	-5°C to +60°C	5°C to +60°C-AC
		25°C to +60°C-Si



Add on RCD Block

Vigi xC60 & Vigi C120

Type AC	Sensitivity	References			Module Width
		30mA	100mA	300mA	
2P 	25 A	A9N26581	A9N26582	A9N26583	1.5
	63 A	A9N26611	A9N26612	A9N26613	2
	125A	A9N18563		A9N18564	3.5
	Module Width				
4P 	25 A	A9N26595	A9N26596	A9N26597	3
	63 A	A9N26643	A9N26644	A9N26645	3.5
	125A	A9N18569		A9N18570	5
	Module Width				

RED: a NEW range of Recloser Earth Leakage Devices



- The RED provides solution that is:
Simple: Complete product for protection against Earthleakage and resetting.
Reliable: System is restored to operation quickly, in optimum safety conditions.

Reclosure Operation

- The built-in automatic recloser automatically recloses the residual current device after checking insulation of the installations.
- If the installation is still faulty: in this case a new check will be carried out in 15mins.
- If the fault was temporary and has disappeared: the recloser automatically recloses the REDs.

Current Rating	25-100A
Voltage rating (Ue)	230 V AC
Impulse withstand voltage (Uimp)	4 kV
Sensitivity	30mA/300mA
Class	A (Protection in presence of DC components in the circuit)
RED status indication	Mechanical: by O-I (open-closed) 2-position lever
	Electrical: by 1 red indicator light on the front panel
Terminal Capacity	Flexible upto 25 sqmm
	Rigid upto 35 sqmm

** For more details Please contact Schneider-Electric Customer Care Centre
 (Email: customercare.in@schneider-electric.com)

New range of MCBs, RCDs and DBs

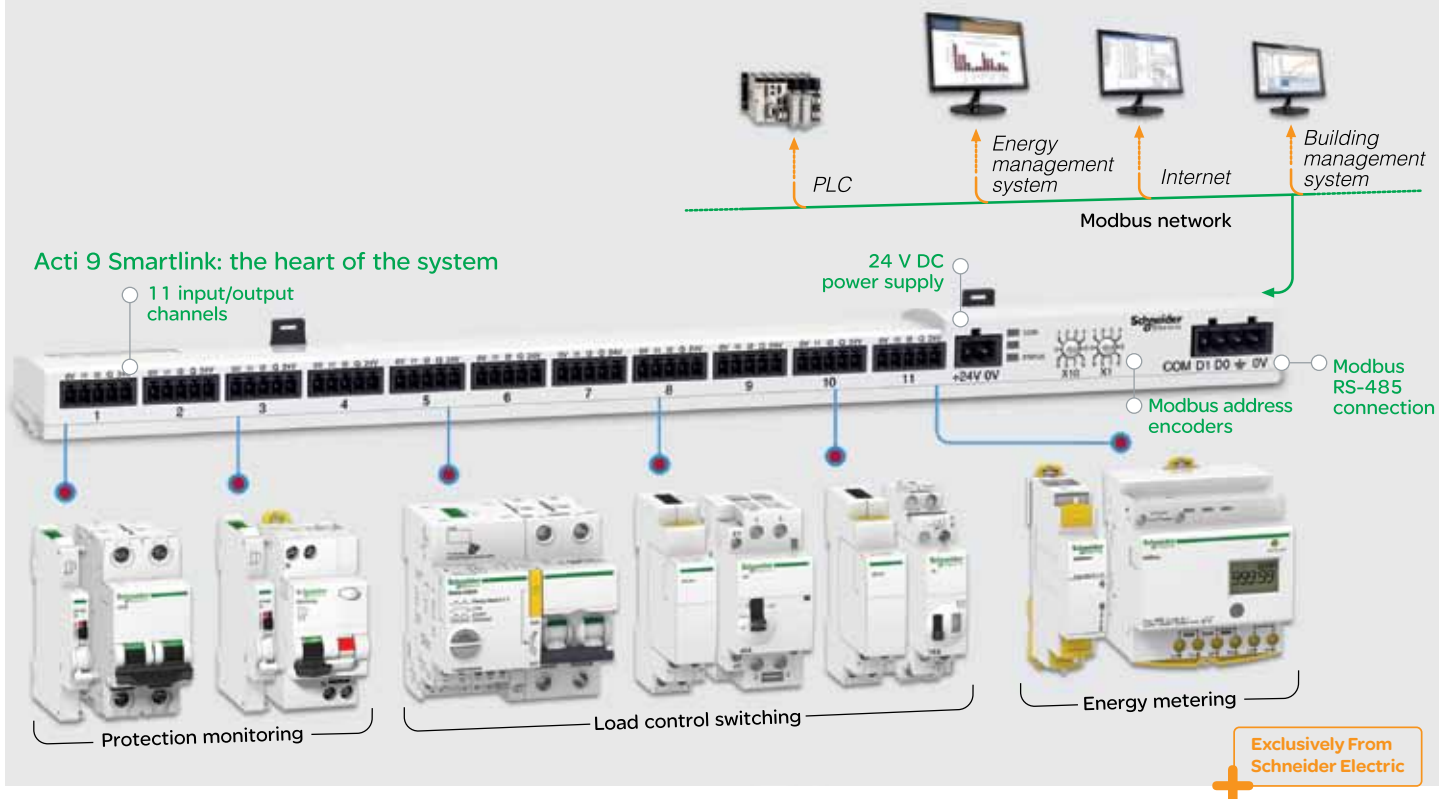

Govern your System Efficiently

- > **Reduced Downtime**
 - Centralized and Detailed load control
 - Remote monitoring through universal MODBUS protocol
 - 100% preventive maintenance

Green Products
 100% Recyclable and Recoverable
 REACH and RoHS compliant

Protection Devices

Surge Protection Devices



For Effective Protection Against Surges caused due to:

- Direct Lightning Strike > Type 1 SPD
- Indirect Lightning Strike > Type 2 SPD
- Switching Surges > Type 2 SPD

Key Benefits

- Withdrawable type: Easy Replacement
- Inbuilt SPD health indicator
- Special SPDs for photovoltaic application and low voltage applications
- Also available with remote signaling
- Unique Quick PRD SPDs with inbuilt MCB protection
- Remote monitoring possible via Smart Link through inbuilt indication auxiliary for SPD health status



Green Products

100% Recyclable
and Recoverable
REACH and RoHS
compliant

Protection Devices

Surge Protection Devices (SPDs)

PRD 125r

Type 1+2 SPDs

IEC 61643-1 T1 : IEC 61643-1,T2

EN 61643-11 Type 1 : EN 61643-11,Type 2

Key Features

- Integrated solution with type1 & type2 Surge Protection levels
- To protect against direct, indirect lightning surges and switching surges
- Fitted with a remote indication contact for end-of-life indication
- Low Response time - ≤ 25 ns
- Easy-to-replace withdrawable cartridges.
- Level of protection (Up) < 1.5kV

Technical Data

PRD1 25r		
Operating frequency		50 Hz
Iimp / Imax		25kA/40kA
End-of-life indication	Local notification	White: correct operation Red: at end of life
	Remote notification	1 A/250 V AC 0.2 A/125 V DC
By tunnel terminal	Rigid Cable	2.5...35 mm
	Flexible Cable	2.5...25 mm
Operating temperature		-25°C to +60°C
Standards	Type 1	IEC 61643-1 T1 EN 61643-11 Type 1
	Type 2	IEC 61643-1 T2 EN 61643-11 Type 2
Continuous operating voltage (UC)		350 V



SPD PRD 125r



Poles	Type	Reference	Module Width
1P	(Type1+2)	16329	2
3P+N		16330	4
3P		16331	6
3P+N		16332	8

Surge arresters	Spare cartridge		
	Phase		Neutral
	Type 1	Type 2	
PRD1 25r			
PRD1 25r 1P	16315	16316	-
PRD1 25r 1P+N	16315	16316	16317
PRD1 25r 3P	3 x 16315	3 x 16316	-
PRD1 25r 3P+N	3 x 16315	3 x 16316	16317

Protection Devices

Surge Protection Devices (SPDs)

iPRD Surge Arrestors

Type 2 and 3 SPDs

(Withdrawable Surge Arrestors)

IEC 61643-1 T2 and EN 61643-11 Type 2

Key Features

- SPD Type 2 & Type 3
- Effective protection against
 - Indirect lightning surges
 - Switching surges
- Response time < 25 ns
- Brings down surge voltage level to less than 800V (which is much lesser than the safe voltage of 1.5kA of Sensitive-category 1 equipments) in Cascading
- SPD Type 3
Secondary protection: placed near the loads to be protected when they are at a distance of more than 30 m from the incoming surge - iPRD8

Technical Data

Main characteristics	iPRD Surge Arrestors
Operating voltage (Ue)	230/400 V AC
I _{max}	8kA to 65kA
Type of Protection	65kA to 20kA - Type 2 & 8kA - Type3
End of life indication: By mechanical indicator	White Red
End of life remote indication	In operation At end of life
Operating temperature	By contact NO, NC 250 V/ 0.25A
Type of connection terminals	-25°C to +60°C Rigid upto 25 sqmm Flexible upto 16 sqmm



SPD iPRD					
Poles	References				Module Width
	I _{max} /I _n	I _{max} /I _n	I _{max} /I _n	I _{max} /I _n	
1P	65 kA / 20 kA A9L16556	40 kA / 15 kA	20 kA / 5 kA	8 kA / 2.5 kA	1
		A9L16561 **			1
		A9L16566			1
			A9L16571		1
				A9L16576	1
1P+N	A9L16557				2
		A9L16562 **			2
		A9L16567			2
			A9L16572		2
				A9L16577	2
3P	A9L16443				3
		A9L16445 **			3
		A9L16568			3
			A9L16447		3
				A9L16449	3
3P+N	A9L16559				4
		A9L16564 **			4
		A9L16569			4
			A9L16574		4
				A9L16579	4

Spare cartridges for

Type	SPD	Reference
C 65-460	iPRD65r IT	A9L16682
C 65-340	iPRD65r	A9L16681
C 40-460	iPRD40r IT	A9L16684
C 40-340	iPRD40, iPRD40r	A9L16685
C 20-460	iPRD20r IT	A9L16686
C 20-340	iPRD20, iPRD20r	A9L16687
C 8-460	iPRD8r IT	A9L16688
C 8-340	iPRD8, iPRD8r	A9L16689
C neutral	All products	A9L16691

Surge arrester/circuit breaker association	
Type of surge arrester	Associated circuit breaker
iPRD65	Curve C 50 A
iPRD40	Curve C 40 A
iPRD20	Curve C 25 A
iPRD8	Curve C 20 A

**SPDs with Remote notification

Surge Protection Devices (SPDs)

iQuick PRD : Compact : SPD + Inbuilt MCB Type 2 or Type 3 (Withdrawable type)



Operating frequency	50/60 Hz	
Operating voltage (Ue)	230/400 V AC	
Imax Rating	Type2	40kA - High risk level 20kA - Moderate Risk level
	Type3	8kA - Protection of the nearby loads located at more than
Response time	<25ns	
Operating temperature	-25°C to +70°C	
Remote indication end of life	By the NO/NC remote indication contact 250 V AC / 2 A	
Status Indication	White - Operational Red - At the end of life	

iPRC, iPRI surge arresters Surge Protection for communication systems (Analog & Digital)



Characteristics	iPRC	iPRI
Number of protected lines	2	2
Limitation voltage (Up)	300 V	70 V
Rated discharge current (8/20) (In)	10 kA	10 kA
Maximum discharge current (8/20) (Imax)	18 kA	10 kA
Response time	< 500 ns	< 1 ns
Nominal impulse current	100 A	70 A
Rated current (IN)	450 mA (up to 45°C)	300 mA (up)
Series resistor	2.2 Ω	4.7 Ω
End-of-life information by	Loss of dialling tone	Loss of transmission

iPRD PV-DC surge arresters Surge Protection for Photovoltaic Applications
IEC 61643-1 T2/EN 61643-11 Type 2



Type of network	Isolated direct current
Response Time	<25ns
Short circuit current (ISCPV)	30 A
Type of surge arresters	Type2
End-of-life indication mode	Available
Operating temperature	-25°C to +60°C
Rated Voltage	650
	1000 VDC

** For more details Please contact Schneider-Electric Customer Care Centre
(Email: customer care.in@schneider-electric.com)

Protection Devices

Auxiliaries for Protection Devices



- Total flexibility – all auxiliaries are Field fittable
- Clip-fit design – does not require any tool to fit
- Ease selection – Same aux is suitable for xC60 and C120 range of MCBs and RCCBs
- Modular Design – fits in regular distribution boards
- Quality Assurance – conform to global standards
- Advance protection and Control:
 - Undervoltage protection : MN
 - Overvoltage Protection : MSU
 - Remote tripping of Devices : MX+OF

MN

- Instantaneous Undervoltage Release
- Causes the device with which it is associated to trip when input voltage decreases (between 70 % and 35 % of U_n)



Rated Voltage	220-240V, 48V AC 48V DC
Mechanical state indicator	Front face
Width in 18mm module	1
Reference Number	A9N26960 (220-240V, 48V AC) A9N26961 (48V DC)

MNs

- Delayed Undervoltage Release
- Causes the device with which it is associated to trip when input voltage decreases (between 70 % and 35 % of U_n)
- No tripping in case transient voltage drops (up to 0.2s)



Rated Voltage	220-240V AC
Mechanical state indicator	Front face
Width in 18mm module	1
Reference Number	A9N26923

MNx

- Independent of Supply
Tripping of the associated device by opening of the control circuit
- A drop in the supply voltage does not trip the associated device.



Rated Voltage	230V, 240V AC
Mechanical state indicator	Front face
Width in 18mm module	1
Reference Number	A9N26969 (230 V AC) A9N26971 (400 V AC)

MSU

- Overvoltage Release
Cuts off the power supply by opening the device with which it is associated when the phase/neutral voltage is exceeded



Rated Voltage	230V AC
Mechanical state indicator	Front face
Width in 18mm module	1
Reference Number	A9N26500

MX

- Shunt Release
- Trips the associated device when it is powered on
- Emergency stop via a normally-open pushbutton



Rated Voltage	100-415V, 48V, 12-24V AC, 110-130V, 48V, 12-24V DC
Mechanical state indicator	Front face
Width in 18mm module	1
Reference Number	A9N26476 (110-415V AC, 110-130 VDC) A9N26478 (12-24VAC/ DC) A9N26477 (48 V A/DC)

OF (On/Off)

- Changeover contact indicating the "open" or "closed" position of the associated device



Rated Voltage	24-415V AC 24-130V DC
Test function	Front face
Width in 18mm module	0.5
Reference Number	A9N26924

OF+SD/OF

- On/Off + Trip on Fault auxiliary
Double open/closed or fault indicating contact.
Two-in-one product: OF+SD or OF+OF



Rated Voltage	24-415V AC 24-130V DC
Test function	Front Face
Mechanical state indicator	Front face
Width in 18mm module	0.5
Reference Number	A9N26929

OF.S

- Changeover contact indicating the "open" or "closed" position of the associated device



Rated Voltage	24-415V AC 24-130V DC
Width in 18mm module	0.5
Reference Number	A9N26923

Compulsory for the addition of tripping or indication auxiliaries on xID RCCBs

OF+SD24

Double changeover contact which can report to Acti 9 smartlink or programmable logic controller:

- Electrical fault
- Actuation of the tripping auxiliary
- Open/Closed position of the associated device.



Rated Voltage	24V DC
Test function	on toggle
Mechanical state indicator	Front face
Width in 18mm module	0.5
Reference Number	A9N26899

SD

- Fault indicating contact
- Changeover contact indicating position of associated device in event of electrical fault



Rated Voltage	24-415V AC 24-130V DC
Test function	Front face
Width in 18mm module	0.5
Reference Number	A9N26927



Acti 9 Smartlink: the heart of the system

Exclusively From Schneider Electric

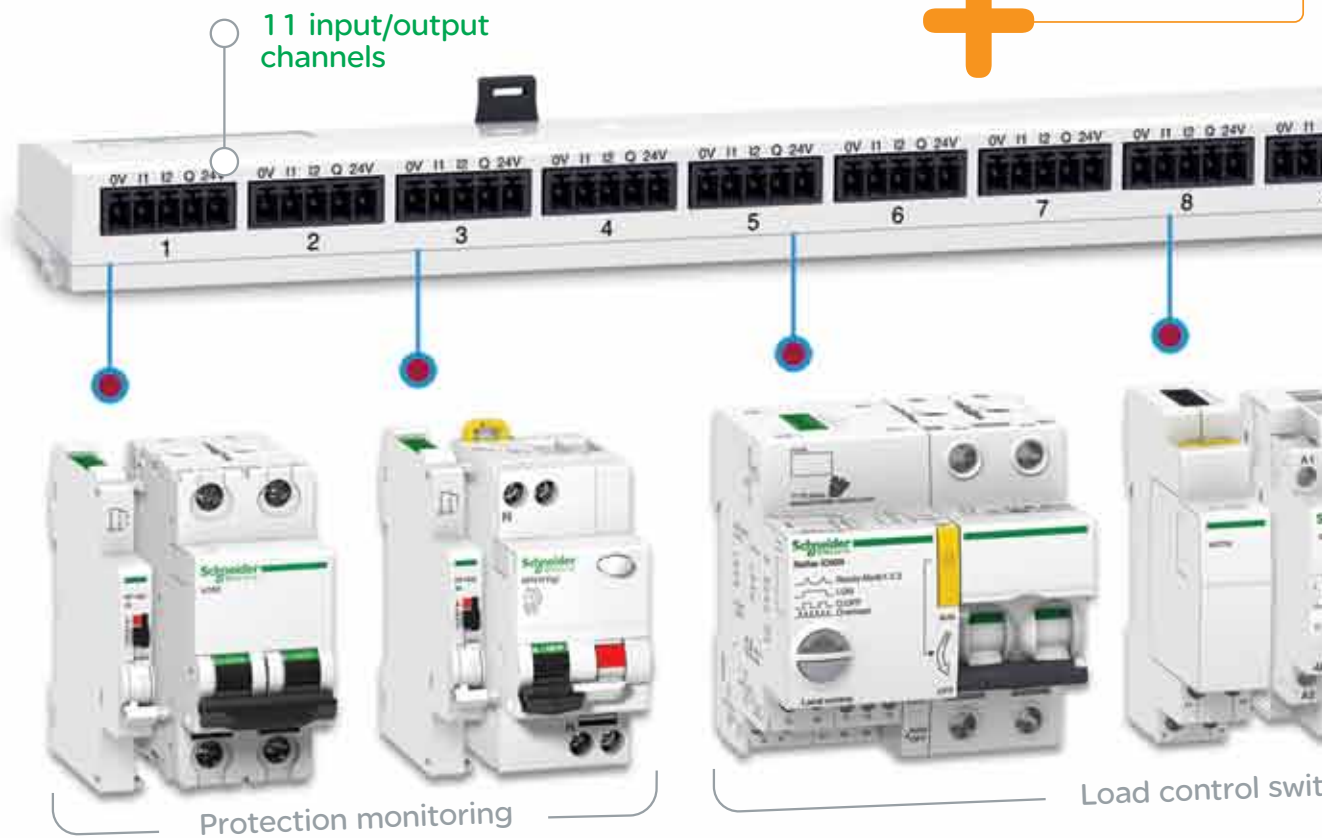

Meets the challenge of all your applications

Detailed load control, reduced downtime, and accurately planned maintenance

Ready to connect to any facility management solution

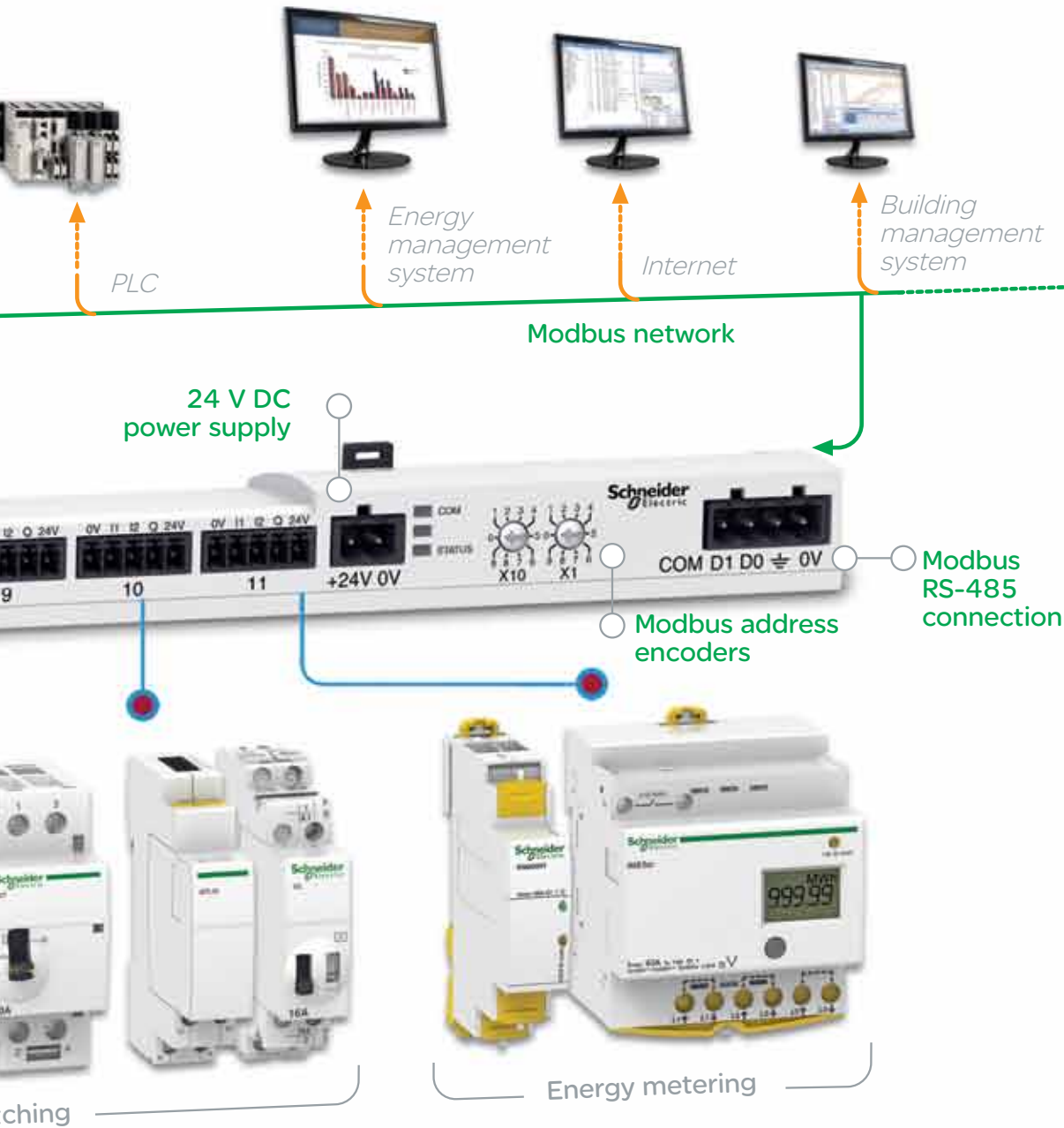

Green Products

100% Recyclable and Recoverable
REACH and RoHS compliant

Key Features

- Remote control by latched and/or impulse order according to 3 modes.
- Circuit breaker provides protection against:
 - Overload currents
 - Short-circuit currents
 - Disconnection in the industrial sector
- 3 operating modes: For various applications
- For safe lock down: Integrated Padlocking
- Simplified maintenance: Front face indicator allows better reliability
- The Ti24 interface also allows fast, reliable connection of the Reflex iC60 to the Acti 9 Smartlink thanks to the prefabricated cables.

Technical Data

Rating	10 to 63A	
Poles	2P/3P/4P	
Supply Voltage	230VAC - 50Hz	
Control voltage	Inputs (Y1/Y2)	230 V AC - 5 mA
	Input (Y3)	24...48 V AC/DC
Rated impulse withstand Voltage	Set to Disconnected - 6kV	
	Set to Ready - 4kV	
Breaking capacity	20kA	
Operating Temp	-25°C to + 60°C	
Terminal Capacity	Power connection	upto 25A: Rigid: 25 sqmm; Flexible: 16sqmm above 25A : Rigid: 35 sqmm; Flexible: 25sqmm
	Control Connection	Power supply: Rigid : 10 sqmm; flexible: 6 sqmm Outputs: 2.5 sqmm Ti24 interface upto 1.5 sqmm



Comm Ready Devices

Type Curve	Rating (In)	2P			3P			4P		
		B	C	D	B	C	D	B	C	D
Reflex iC60N With Ti24 interface	10A	A9C61210	A9C62210	A9C63210	A9C61310	A9C62310	A9C63310	A9C61410	A9C62410	A9C63410
	16 A	A9C61216	A9C62216	A9C63216	A9C61316	A9C62316	A9C63316	A9C61416	A9C62416	A9C63416
	25 A	A9C61225	A9C62225	A9C63225	A9C61325	A9C62325	A9C63325	A9C61425	A9C62425	A9C63425
	40 A	A9C61240	A9C62240	-	A9C61340	A9C62340	-	A9C61440	A9C62440	-
	63 A	A9C61263	A9C62263	-	A9C61363	A9C62363	-	A9C61463	A9C62463	-
Module Width		4.5			5.5			6.5		

Key Features

- For remote control applications in alternative networks:
 - lighting, heating, ventilation, roller blinds, sanitary hot water
 - mechanical ventilation systems, etc
 - load-shedding of non-priority circuits
- 4 operating modes switch on front face:
 - Automatic mode
 - Temporary "ON" mode
 - Permanent "ON" mode
 - Shutdown
- Mechanical contact position indicator
- Safe installation maintenance: lock the contactor in ON position

Technical Data

Voltage rating (Ue)	230-240 V 400 V AC
Electrical Endurance (O-C)	100,000 cycles
Insulation voltage (Ui)	500 V AC
Pollution degree	2
Rated impulse withstand voltage (Uimp)	2.5 kV (4 kV for 12/24/48 V AC)
Operating temperature	-5°C to +60°C (1)



Comm Ready Devices

iCT Contactors



Rating		Control Voltage (VAC)	Contact	Reference	Module Width
AC7a	AC7b				
25A	8.5A	230...240	1NO	A9C20731	1
16A	6A	230-240	2NO	A9C22712	1
25A	8.5A	230-240	2NO	A9C20732	1
40A	15A	220-240	2NO	A9C20842	2
63A	20A	220-240	2NO	A9C20862	2
25A	8.5A	220...240	3NO	A9C20833	2
40A	15A	220...240	3NO	A9C20843	3
63A	20A	220...240	3NO	A9C20863	3
25A	8.5A	220-240	4NO	A9C20834	2
40A	15A	220-240	4NO	A9C20844	3
63A	20A	220-240	4NO	A9C20864	3
63A	20A	220-240	2NO+2NC	A9C20868	3

Key Features

- Used to control, by means of pushbutton, lighting circuits consisting of:
 - Incandescent lamps, low voltage, halogen lamps, etc. (resistive loads)
 - Florescent lamps, discharge lamps, etc. (inductive loads)
 - Safe maintenance: Disconnection of remote control by selector switch
 - Manual Controls on front face: 0-I toggle
 - Mechanical contact position indicator

Technical Data

Rating	16A/32A	
Voltage Rating	230-240VAC, 110V DC	
Terminal Capacity	16A	Rigid: Upto 4 sqmm Flexible: Upto 4 sqmm
	32A	Rigid: Upto 4 sqmm Flexible upto 10sqmm
Pollution degree	3	
Rated impulse withstand voltage (Uimp)	6 kV	
Endurance (O-C)	100,000 cycles (AC22)	



Comm Ready Devices
iTL impulse relays

	Rating		Module	Poles
	16A	32A		
 	A9C30811	A9C30831	1	1
 	A9C30812	A9C30831 + A9C32836	1	2
 	A9C30811 + A9C32816	A9C30831 + 2 x A9C32836	2	3
 	A9C30814	A9C30831 + 3 x A9C32836	2	4

Control and Indication Devices

Communication Ready Devices

Smartlink

(Heart of Acti 9 Communication System)

- The Acti 9 Smartlink transmits data from Acti 9 devices to a PLC or supervision system via the Modbus serial line communication network
- Modbus processing interface providing:
 - Circuit Breaker status
 - Energy meter output
 - Contactor/Impulse relay control and status
- Smart functions integrated
 - Energy counting from pulses
 - Average power calculation
 - Event counting
 - Running hours
- Fast, safe and simplified cabling: Pre-fabricated cables

Power Supply	
Rated Voltage	24 V DC \pm 20 %
Maximum input current	1.5 A
Maximum inrush current	3A
Meter	Capacity 2 ²³ pulses per input
Environmental characteristics	
Operating temperature	-25°C ... +60°C if vertical mounting, limited to 50°C
Degree of protection	3
Input characteristics	
Number of channels	11 2-input channels
Maximum cable length	20 m
Rated voltage	24 V DC
Rated current	2.5 mA
Output Characteristics	
Number of output channels	11
Rated voltage	24 V DC
Maximum current	100 mA
Terminal Capacity	Rigid-0.5 to 1.5 mm
	Flexible-0.5 to 1.5mm





Smartlink



Type	Set	References
Acti 9 Smartlink with	1	A9XMSB11
+ 240V DC Supply	1	
+ ModbusConnector	1	
+ Locking clips for Multiclip 80A	2	

Smartlink Accessories

Accessories	Reference
Link USB / Modbus for Acti 9 Smartlink test	A9XCATM1
Prefabricated cables	
 With 2 connectors	Short: 100 mm 6 A9XCAS06
	Medium-sized: 160 mm 6 A9XCAM06
	Long: 870 mm 6 A9XCAL06
 With 1 connector	Long: 870 mm 6 A9XCAU06
	Connectors 5-pin connectors (Ti24) 12 A9XC2412
 Mounting kit	DIN rail (4 feet, 4 straps, 4 adapters) 1 A9XMFA04
	Multiclip 200 A (4 adapters) 1 A9XM2B04
Spare parts	Lock for Multiclip 80A (2 clips) 1 A9XMLA02

Key Features

- Digital kilowatt-hour meters designed for sub-metering of active energy (rms) consumed by a single-phase or three-phase electric circuit with or without distributed neutral.

Technical Data

Designation	iEM2000T	iME
Rating	0-40 A	0-63 A
Accuracy Class	1	1
Consumption	< 10 VA	2.5 VA
Operating Temperature	-25 to 65°C if < 32 A -25 to 55°C if = 32 A	-25 to 55°C
LED light indicator	Consumption: 0.3 W Service Life: 100,00 hours	





Energy Meters



Phase	Voltage	Metering	Reference Number	Module Width
Single + Neutral	230, +20%	3,200 flashes/kWh	A9MEM2000T	1
		1,000 flashes/kWh	A9M17067	2
Three	400, ±20%	100 flashes/kWh	A9M17076	4
Three + Neutral	230, +20%	100 flashes/kWh	A9M17071	4



iACT24 (Control and Indication)

- **Auxiliary for Contactors:**
Allows a contactor to be interfaced with the Acti 9 Smartlink interface or a programmable logic controller in 24 V DC

	Control Voltage	230V AC (Y2) 24V DC (Y3)
	Insulation Voltage	250V AC
	Rated Impulse Withstand Voltage	8KV
	Pollution Degree	3
	Width in 18mm module	1
	Operation Voltage	-25 to + 60°C
	Reference Number	A9C15924
		

iATL24 (Control and Indication)

- **Auxiliary for Impulse Relays:**
Allows an impulse relay to be interfaced with the Acti 9 Smartlink interface or a programmable logic controller in 24 V DC

	Control Voltage	230V AC (Y2) 24V DC (Y3)
	Insulation Voltage	250V AC
	Rated Impulse Withstand Voltage	8KV
	Pollution Degree	3
	Width in 18mm module	1
	Operation Voltage	-25 to + 60°C
	Reference Number	A9C15424
		

Multiclip 80 A

It is a four-pole splitter block 24 modules wide installable on a standard DIN rail.

	Rated Current at 40° C	80A
	Maximum operating voltage	440 V AC
	Rated Insulated voltage	500 V AC
	Rated Impulse Withstand Voltage	6 KV
	Width in 18mm modules	24
	Reference Number	04000

Distribloc 63A/125A splitter block

- 4P Splitter Block mountable on the DIN Rail and modular in shape
- Outgoing feeders are connected at the front, without screws, in spring terminals.
- The tunnel terminals are located to facilitate the insertion of cables and clamping by screws
- The spring contact pressure adapts automatically to the cross section of the conductor. It is independent of the operator.
- In the event of an extension to or modification of the switchboard, connection is very easy.

	Terminal Capacity	Rigid: 25 sqmm Flexible: 16 sq mm
	Rated impulse withstand voltage (Uimp)	63A - 6kV 125A - 8kV
	Operating temperature	-25°C to +60°C
	Voltage rating (Ue)	440VAC
	Module width	4Modules
	Standards	IEC/EN 60947-7-1 IEC/EN 61439-2
	<ul style="list-style-type: none"> • 2 rows of terminals: <ul style="list-style-type: none"> ■ 12 connection points for phases (L1, L2, L3) ■ 12 connection points for neutral. 	

Control and Indication Devices

Basic Control and Indication Devices

xSW Isolators

IEC 60669-1; IEC 60947-3







Key Features

- Utilization category: AC-22
- Suitable for DC supply 1P - 48V DC, 2P (in series) - 110V DC
- Short circuit withstand 20In for 1sec.
- Operational Safety at the downstream - Suitability for Isolation

Technical Data

Current Rating	40A to 125A
Rated Voltage	240-415 VAC
Insulated Voltage	500V AC
Impulse Withstand Voltage	6kV
Permissible rated short-time withstand current (Icw)	1.25kA for 40A 2.5kA for 63-125A
Pollution Degree	3
Operating Temperature	-20 to 50°C

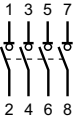

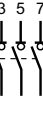
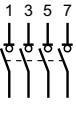
Isolators				
xSW Biconnect				
Poles		Rating	Reference Number	Module Width
2P				
		40A	A9S2P040	2
		63A	A9S2P063	2
		80A	A9S2P080	2
3P				
		40A	A9S3P040	3
		63A	A9S3P063	3
4P				
		40A	A9S4P040	4
		63A	A9S4P063	4
		80A	A9S4P080	4
xSW Monoconnect				
2P				
		100A	A9S2P100	2
		125A	A9S2P125	2
4P				
		100A	A9S4P100	4
		125A	A9S4P125	4

Key Features

- These linear switches are used for the manual control of electric circuits.
- Poles: 1P, 2P
- Available in 2 versions:
- 2 Position (Source-1 - Source-2) and 3 Position (Source-1 - OFF - Source-2)
- Switching Duty : AC-22

Technical Data

Current Rating	20A
Voltage Rating	250 V AC
Endurance	30,000 cycles
Pollution Degree	3
Operating Temperature	-20 to 50°C
Terminal Capacity	upto 10sqmm
Pollution Degree	3
Operating Temperature	-20 to 50°C



Changeover Switches (iSSW)				
Poles	2 positions	Contact	References	Module Width
1P		1 Changeover Switch	A9E18070	1
		2 Changeover Switches	A9E18071	2
		1 NO + 1 NC	A9E18072	1
2P		1 Changeover Switch	A9E18073	1
		2 Changeover Switches	A9E18074	2
		1 NO + 1 NC	A9E18072	1

Control and Indication Devices

Basic Control and Indication Devices

iPB Switches Push Buttons

IEC 60669-1 and IEC 60947-5-1

Key Features

- The pushbuttons are used to control electric circuits by means of pulses.

Technical Data

Current Rating	20A
Voltage Rating	250 V AC
Endurance	30,000 cycles
Pollution Degree	3
Operating Temperature	-35 to 70°C
LED light indicator	Consumption: 0.3 W
Service Life:	100,00 hours



Push Buttons

Single iPB



Contact	Pushbutton Colour	Reference Number	Module Width
1 NC	Grey	A9E18030	1
	Red	A9E18031	1
1 NO	Grey	A9E18032	1
1 NO+1 NC	Grey	A9E18033	1

Double iPB



1 NO/ 1 NC	Green/ Red	A9E18034	1
1 NO/ 1 NO	Grey/ Grey	A9E18035	1

Single + Indication light iPB



Contact	Pushbutton Colour	Power Supply	Light Colour	Reference Number	Module Width
1 NO	Grey	110-230	Green	A9E18036	1
1 NC		V AC	Red	A9E18037	1
1 NO		12-48	Green	A9E18038	1
1 NC		V AC/DC	Red	A9E18039	1

Key Features





- LED Indicators
- Longer service life
- Low power consumption
- High visibility

Technical Data

Operating Frequency	50-60 Hz
Pollution Degree	3
Operating Temperature	-35 to 70°C
LED light indicator	Consumption: 0.3 W
Service Life	100,00 hours



Indicator Lights

	Colour	Voltage	Reference Number	Module Width
	Red	110-230 V AC	A9E18320	1
	Green		A9E18321	1
	Blue		A9E18323	1
	Yellow		A9E18324	1
Double iIL	Green/ Red	110-230 V AC	A9E18325	1
				
Flashing Light	Red	110-230 V AC	A9E18326	1
				
3-phase voltage presence indication light	Red/ Red/ Red	230-400 V AC (3 phase)	A9E18327	1
				

Key Features

- Modular DB mounted bells & buzzers

Technical Data

Consumption	8-12 V AC	--	3.6 VA
	220-240 V AC	--	5 VA
Degree of protection	IP40 (Device only)		
	IP20 (Device in modular enclosure)		
Operating Temperature	-10 to 40°C		
Sound level (at a distance of 60cm)	SO	-	80 dBA
	iRO	-	70 dBA



Control & Indication Devices

SO Bell



Voltage	Reference Number	Module Width
230 V AC	15320	1
8-12 V AC	15321	1

iRO Buzzer



230 V AC	A9A15322	1
8-12 V AC	A9A15323	1

Key Features

- Automatically switch On and Off loads according to the program entered by the user with 4 keys and a display, they operate on a weekly cycle: the same program is repeated week after week.
- Rating: 16A (can be used for application up to 100A with use of contactor)
- Memory: 56 switching operations and 84 switching operations
- Cycle - 24 hrs and/or 7days
- Battery back up - 6years (by in-built Li battery)
- Program from PC version also available 3mode operation - ON-OFF-AUTO
- Available in Digital and Mechanical version

Technical Data

Designation	IHP 1c	IHP+1c	IHP 2c	IHP+2c	IH+1c ARM	IH 1c ARM
Voltage Rating (V AC)	230 ±10%				230 +10% -15%	230 ±10%
Consumption	4 VA		7 VA		2.5 VA	
Degree of protection	IP20B					
Operating Temperature	-10 to 50°C				-20 to 55°C	-10 to 50°C



Control & Indication Time Switches



Type	Number of channels	Cycle period	Minimum Time between 2 switching operations	Reference Number	Module Width
IHP 1c	1	24h and/or 7d	1 min.	CCT15720	2.5
IHP + 1c	1	24h and/or 7d	1 s	CCT15721	2.5
IHP 2c	2	24h and/or 7d	1 min.	CCT15722	2.5
IHP + 2c	2	24h and/or 7d	1 s	CCT15723	2.5



IH + 1c ARM	1+1	24h + 7d	45 min. + 12h	15366	1
IH 1c ARM	1	24h	15 min.	15336	1

A memory key (CT15861) and a programming kit (CCT15860) can be used to duplicate on another IHP+ 1C/2c or to save the program created by the contractor.

> MCB

xC60

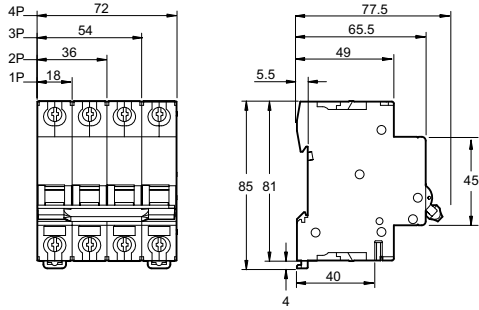

C120N, C120H

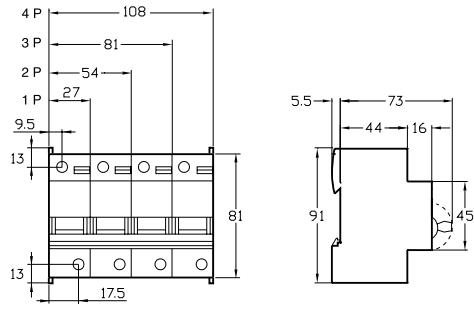

C60H-DC

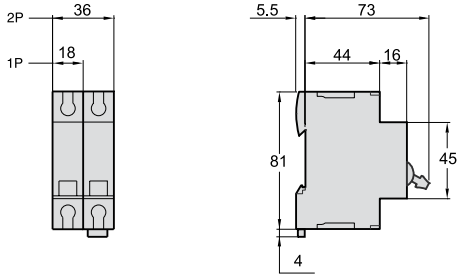

NG125 N/L/H

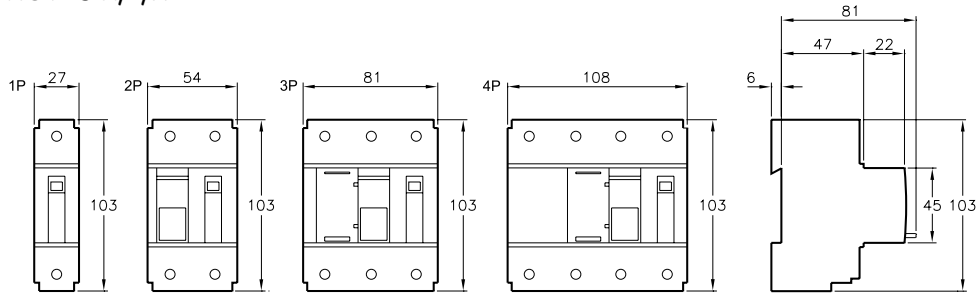

> RCDs

xID RCCB

RCCB-ID 125A

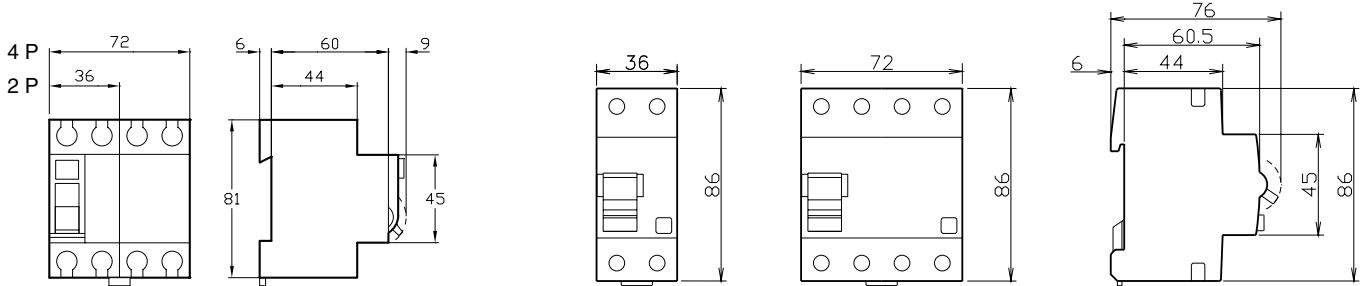

Vigi xC60 25A

Vigi xC60 63A

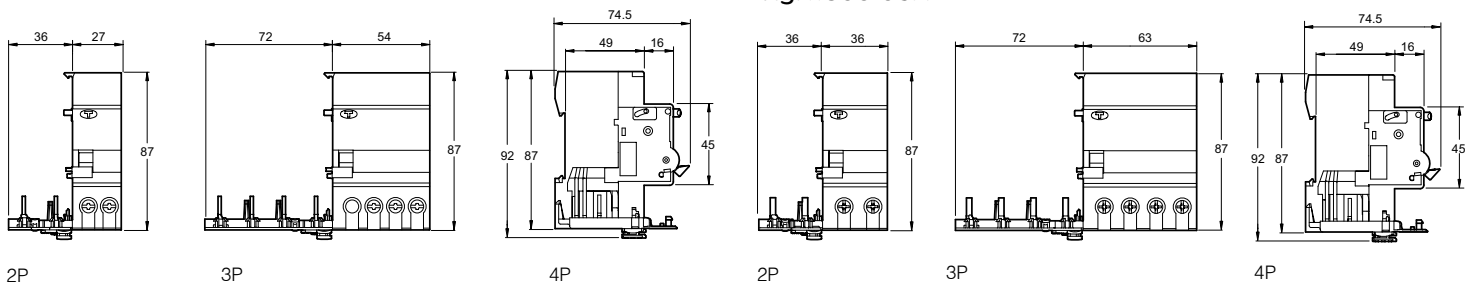

> SPDs

PRD1 25r

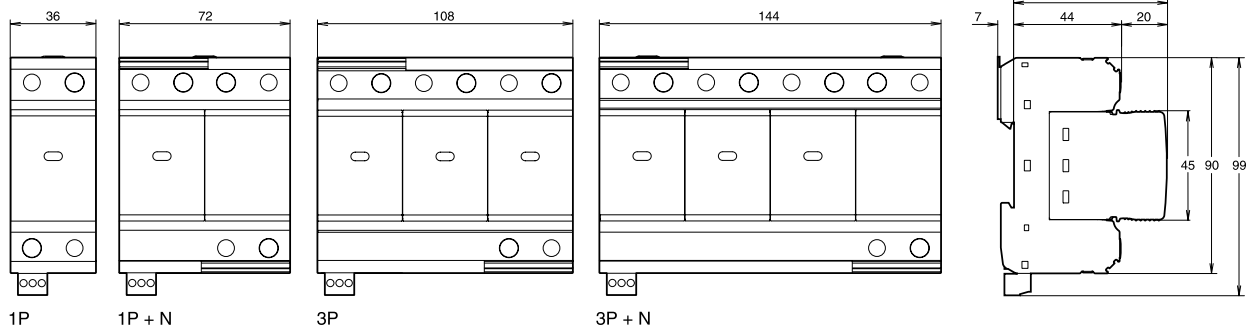

iPRD

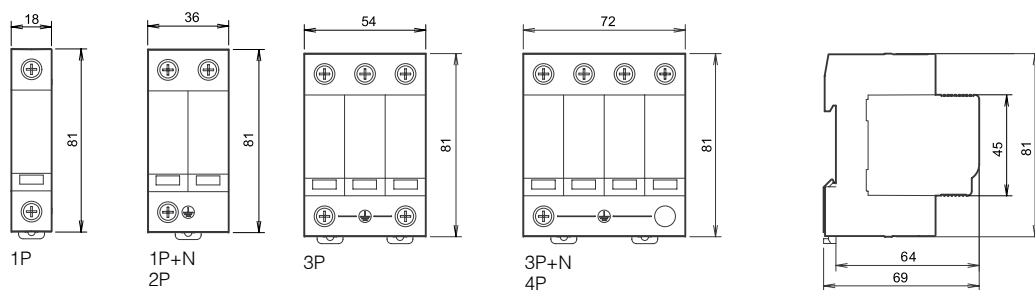

Quick PRD

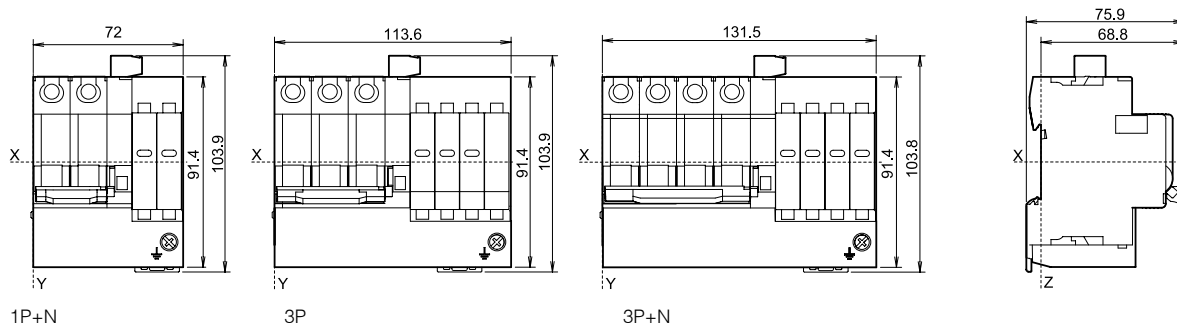

PRI PRC (Special Purpose SPDs)

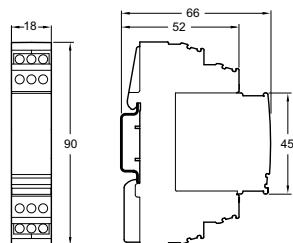

iPRD PV-DC SPD

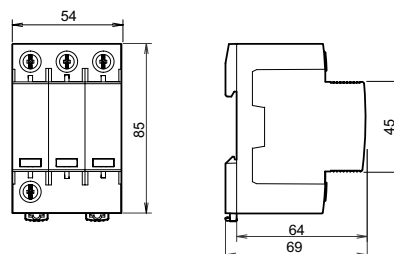

> Auxiliaries

OF, SD, OF+SD/OF - MX, MN, MN \square , MSU, MX+OF, MNx for DPN, DPN Vigi, C60, C120, ID / RCCB

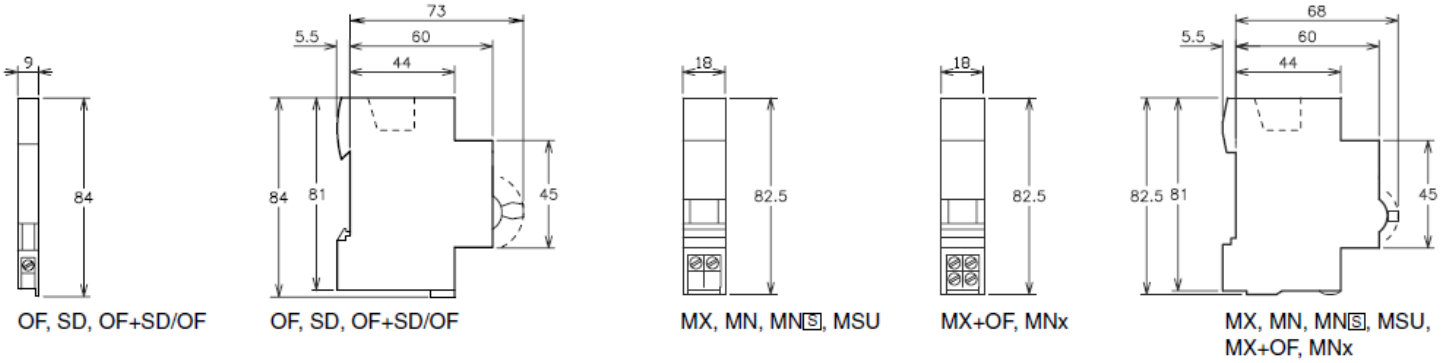

OF, SD, MN, MX, MNx, MN \square for NG125

Ofs for ID / RCCB

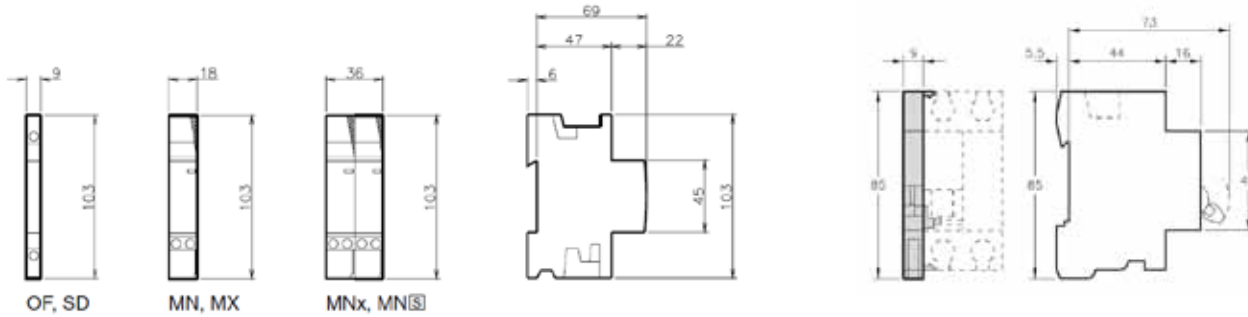

> Communication Ready Devices

Reflex iC60

iTL Impulse Relays

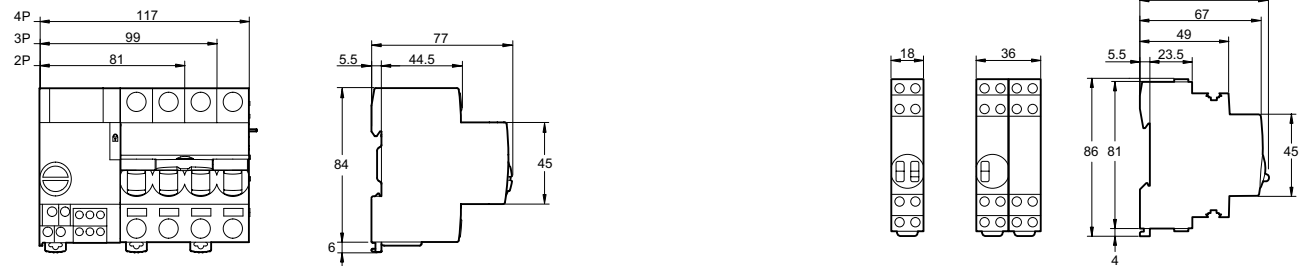

iCT 16/25A

iCT 40/63A

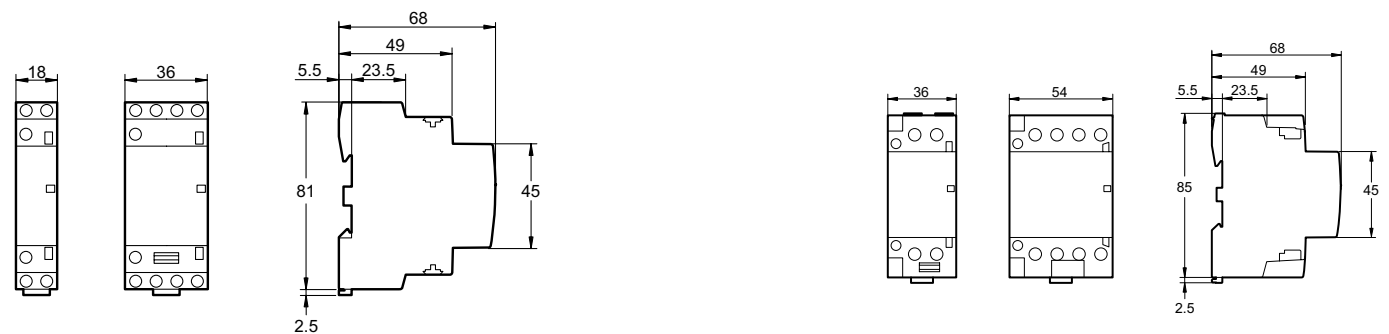

Auxiliary for For iCT - iACT24

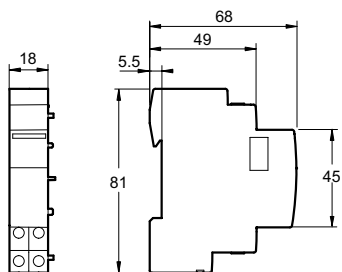

Auxiliary for iTL Impulse Relays - iATL24

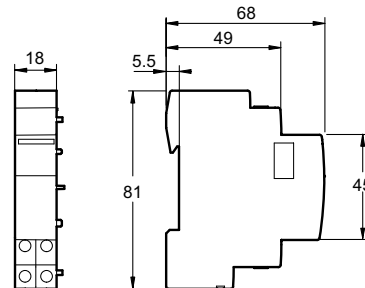

> Accessories

Smartlink

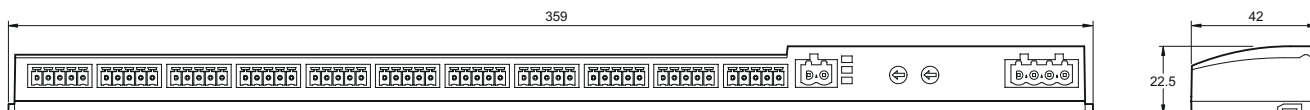

Multiclip

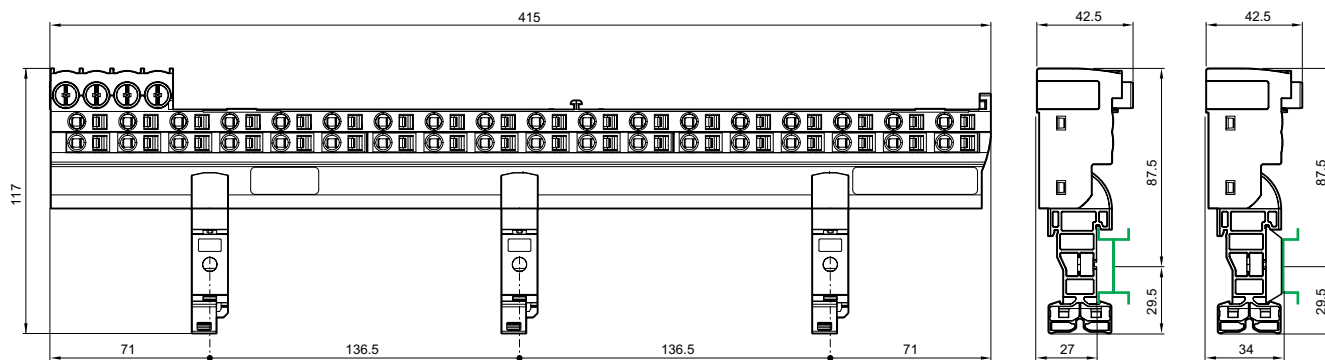

Distribloc 63A

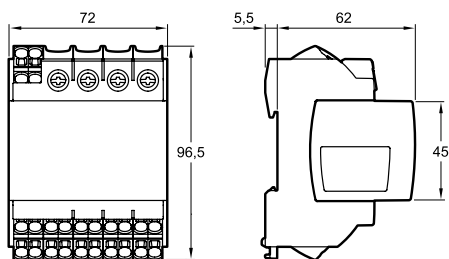

Distribloc 125A

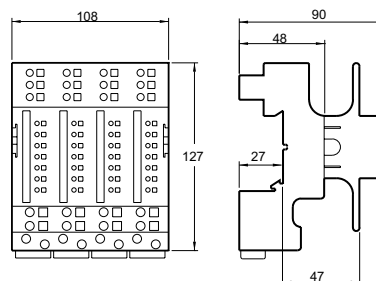

Energy Meter

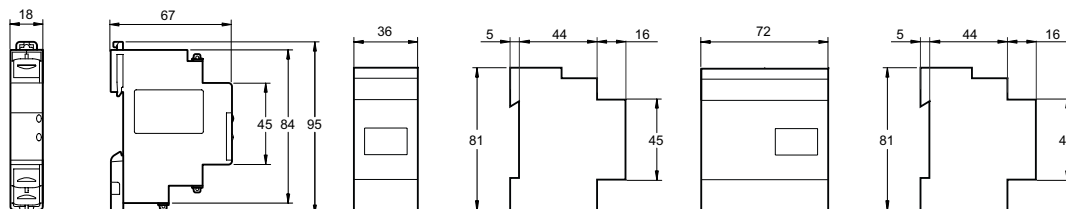

> Basic Control & Indication Devices

xSwitches (Bi-connect)

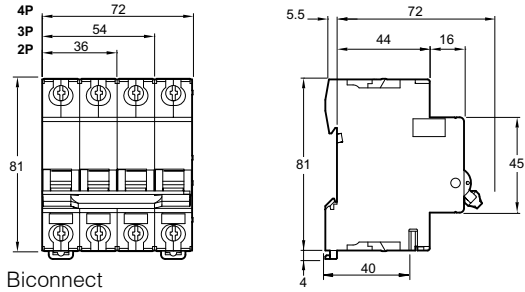

Biconnect

xSwitches (Mono-connect)

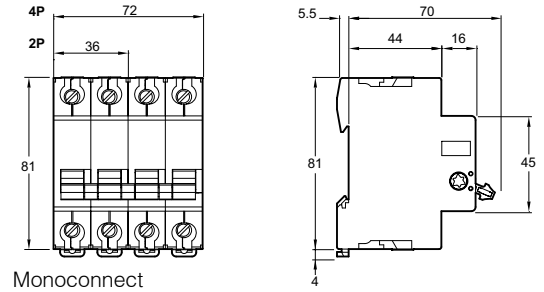

Monoconnect

Changeover switches

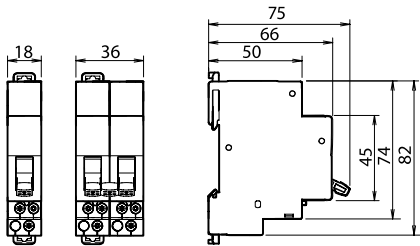

Push Buttons

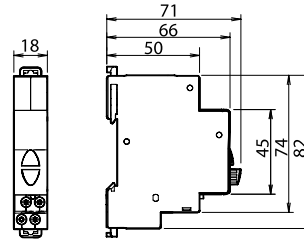

Indicators

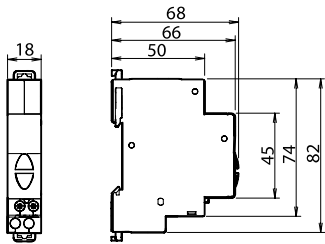

SO Bells & iRO Buzzers

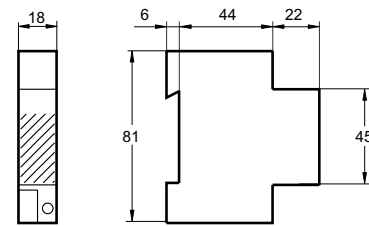

IHP Time Switches

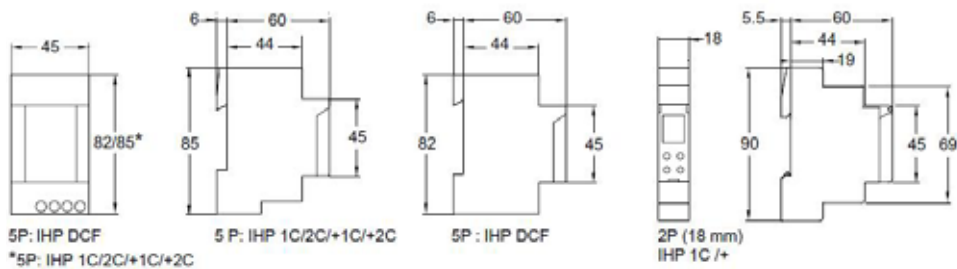

Protection Devices MCBs

The following table indicates the average dissipated power per pole in W for a current equal to the rating of the device and at the operating voltage.

MCBs		
Rating(A)	xC60/C60 H-DC	C120
0.5	2.20	-
1	2.30	-
2	2.60	-
3	2.20	-
4	2.40	-
6	2.70	-
10	1.80	-
16	2.50	-
20	3.00	-
25	3.10	-
32	3.50	-
40	4.30	-
50	4.80	-
63	6.10	-
80	-	3.20
100	-	2.00
125	-	4.10

(Miniature Circuit Breakers)

Tertiary/Industry (IEC 60947-2)

C60 derating table (IEC 60947-2)

C60	Ambient temperature (°C)																				
Rating	-30	-25	-20	-15	-10	-5	0	+5	+10	+15	+20	+25	+30	+35	+40	+45	+50	+55	+60	+65	+70
0.5 A	0.68	0.67	0.66	0.65	0.64	0.63	0.62	0.61	0.6	0.59	0.58	0.56	0.55	0.54	0.53	0.51	0.5	0.49	0.47	0.46	0.44
0.75 A	0.93	0.92	0.91	0.9	0.89	0.88	0.87	0.86	0.85	0.83	0.82	0.81	0.8	0.79	0.78	0.76	0.75	0.74	0.72	0.7	0.68
1 A	1.31	1.3	1.28	1.27	1.25	1.23	1.21	1.19	1.17	1.15	1.13	1.11	1.09	1.07	1.05	1.02	1	0.98	0.95	0.93	0.91
2 A	2.55	2.59	2.56	2.52	2.49	2.45	2.41	2.37	2.34	2.3	2.26	2.22	2.17	2.13	2.09	2.04	2	1.95	1.91	1.88	1.84
3 A	3.81	4.04	3.98	3.92	3.85	3.79	3.73	3.66	3.59	3.52	3.45	3.38	3.31	3.23	3.16	3.08	3	2.92	2.83	2.82	2.76
4 A	4.9	4.86	4.81	4.76	4.7	4.65	4.59	4.54	4.48	4.42	4.37	4.31	4.25	4.19	4.13	4.06	4	3.94	3.87	3.81	3.74
6 A	7.93	7.82	7.71	7.6	7.49	7.38	7.27	7.15	7.03	6.91	6.79	6.66	6.54	6.41	6.27	6.14	6	5.86	5.71	5.56	5.42
8 A	10.37	10.23	10.09	9.96	9.82	9.68	9.54	9.4	9.25	9.11	8.96	8.81	8.65	8.49	8.33	8.17	8	7.83	7.65	7.47	7.31
10 A	13.3	13.2	13	12.8	12.6	12.4	12.2	12	11.8	11.6	11.4	11.2	10.9	10.7	10.5	10.2	10	9.8	9.5	9.2	9
13 A	17	16.9	16.6	16.4	16.2	15.9	15.7	15.4	15.2	14.9	14.7	14.4	14.1	13.9	13.6	13.3	13	12.7	12.4	12.1	11.8
16 A	20	19.8	19.5	19.3	19.1	18.8	18.6	18.4	18.1	17.9	17.6	17.3	17.1	16.8	16.6	16.3	16	15.7	15.4	15.1	14.8
20 A	26.9	26.6	26.2	25.8	25.4	25	24.6	24.2	23.7	23.3	22.9	22.4	22	21.5	21	20.5	20	19.5	18.9	18.4	17.9
25 A	32.9	32.5	32.1	31.6	31.1	30.7	30.2	29.7	29.2	28.7	28.2	27.7	27.2	26.7	26.1	25.6	25	24.4	23.8	23.2	22.6
32 A	41.5	41.1	40.5	40	39.4	38.9	38.3	37.7	37.1	36.5	35.9	35.3	34.7	34	33.4	32.7	32	31.3	30.6	29.9	29.1
40 A	53.7	52.9	52.2	51.4	50.6	49.8	49	48.2	47.3	46.5	45.6	44.7	43.8	42.9	42	41	40	39	37.9	36.9	35.8
45 A	60.8	60.1	59.2	58.3	57.4	56.5	55.5	54.6	53.6	52.6	51.6	50.5	49.5	48.4	47.3	46.2	45	43.8	42.6	41.4	40.1
50 A	65	64.3	63.5	62.6	61.7	60.8	59.9	59	58.1	57.1	56.2	55.2	54.2	53.2	52.1	51.1	50	48.9	47.8	46.7	45.5
63 A	85.5	84.6	83.3	82	80.7	79.4	78	76.7	75.3	73.9	72.4	70.9	69.4	67.9	66.3	64.7	63	61.3	59.5	57.8	56

C60H-DC derating table (IEC 60947-2)

C60H-DC	Ambient temperature (°C)																				
Rating	-30	-25	-20	-15	-10	-5	0	+5	+10	+15	+20	+25	+30	+35	+40	+45	+50	+55	+60	+65	+70
0.5 A	0.63	0.62	0.61	0.6	0.59	0.58	0.56	0.55	0.54	0.53	0.51	0.5	0.49	0.47	0.46	0.44	0.43	0.41	0.39	0.38	0.36
1 A	1.18	1.17	1.15	1.14	1.12	1.1	1.09	1.07	1.05	1.04	1.02	1	0.98	0.96	0.94	0.92	0.9	0.88	0.86	0.84	0.82
2 A	2.54	2.5	2.45	2.41	2.36	2.31	2.26	2.21	2.16	2.11	2.06	2	1.94	1.88	1.82	1.76	1.7	1.63	1.56	1.48	1.41
3 A	3.78	3.71	3.65	3.58	3.51	3.45	3.38	3.3	3.23	3.16	3.08	3	2.92	2.84	2.75	2.66	2.57	2.48	2.38	2.27	2.17
4 A	5.08	4.99	4.9	4.81	4.71	4.62	4.52	4.42	4.32	4.22	4.11	4	3.89	3.77	3.65	3.53	3.4	3.27	3.13	2.98	2.83
5 A	6	5.92	5.83	5.74	5.66	5.57	5.48	5.39	5.29	5.2	5.1	5	4.9	4.8	4.69	4.58	4.47	4.36	4.24	4.12	4
6 A	7.26	7.15	7.04	6.94	6.83	6.71	6.6	6.48	6.37	6.25	6.12	6	5.87	5.74	5.61	5.47	5.33	5.19	5.04	4.89	4.73
10 A	12.6	12.4	12.2	11.9	11.7	11.5	11.3	11	10.8	10.5	10.3	10	9.7	9.5	9.2	8.9	8.6	8.3	7.9	7.6	7.2
13 A	15.5	15.3	15.1	14.9	14.6	14.4	14.2	14	13.7	13.5	13.3	13	12.8	12.5	12.2	12	11.7	11.4	11.1	10.8	10.5
15 A	18.6	18.3	18	17.7	17.4	17.1	16.7	16.4	16.1	15.7	15.4	15	14.6	14.3	13.9	13.5	13	12.6	12.2	11.7	11.2
16 A	19.4	19.1	18.9	18.6	18.3	18	17.6	17.3	17	16.7	16.3	16	15.7	15.3	14.9	14.6	14.2	13.8	13.4	13	12.5
20 A	24.1	23.7	23.4	23	22.7	22.3	21.9	21.6	21.2	20.8	20.4	20	19.6	19.2	18.7	18.3	17.9	17.4	16.9	16.4	15.9
25 A	30.4	29.9	29.5	29	28.5	28.1	27.6	27.1	26.6	26.1	25.5	25	24.5	23.9	23.3	22.7	22.1	21.5	20.9	20.2	19.6
30 A	37.4	36.7	36.1	35.5	34.9	34.2	33.5	32.9	32.2	31.5	30.7	30	29.2	28.5	27.7	26.8	26	25.1	24.2	23.2	22.3
32 A	38.5	37.9	37.4	36.8	36.2	35.7	35.1	34.5	33.9	33.3	32.6	32	31.4	30.7	30	29.3	28.6	27.9	27.1	26.3	25.5
40 A	48.9	48.2	47.4	46.7	45.9	45.1	44.3	43.5	42.6	41.8	40.9	40	39.1	38.2	37.2	36.2	35.2	34.2	33.1	32	30.8
50 A	59.9	59.1	58.3	57.4	56.5	55.6	54.7	53.8	52.9	52	51	50	49	48	46.9	45.9	44.8	43.6	42.5	41.3	40.1
63 A	78.2	76.9	75.6	74.3	73	71.7	70.3	68.9	67.5	66	64.5	63	61.4	59.8	58.2	56.5	54.7	52.9	51.1	49.1	47.1

C120 derating table (IEC 60947-2)

C120	Ambient temperature (°C)																				
Rating	-30	-25	-20	-15	-10	-5	0	+5	+10	+15	+20	+25	+30	+35	+40	+45	+50	+55	+60	+65	+70
80 A	103.7	102.4	101	99.7	98.3	96.9	95.5	94.1	92.6	91.1	89.6	88.1	86.5	84.9	83.3	81.7	80	78.3	76.5	74.7	72.9
100 A	137.6	135.5	133.5	131.4	129.2	127.1	124.8	122.6	120.3	118	115.6	113.1	110.6	108.1	105.5	102.8	100	97.2	94.2	91.2	88.1
125 A	174.6	171.9	169.2	166.4	163.6	160.7	157.8	154.9	151.8	148.7	145.6	142.4	139.1	135.7	132.2	128.7	125	121.2	117.3	113.3	109.1

(Miniature Circuit Breakers)

Alternative current 50/60 Hz

xC60

According to IEC/EN 60898 (reference temperature 30°C)

Curves B, C, D

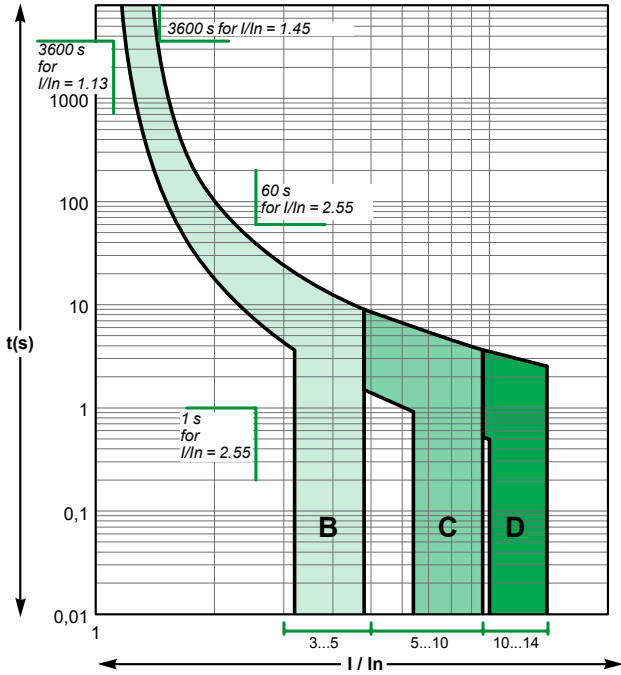

Alternative current 50/60 Hz

C120N/H

According to IEC/EN 60898 (reference temperature 30°C)

Curves B, C, D

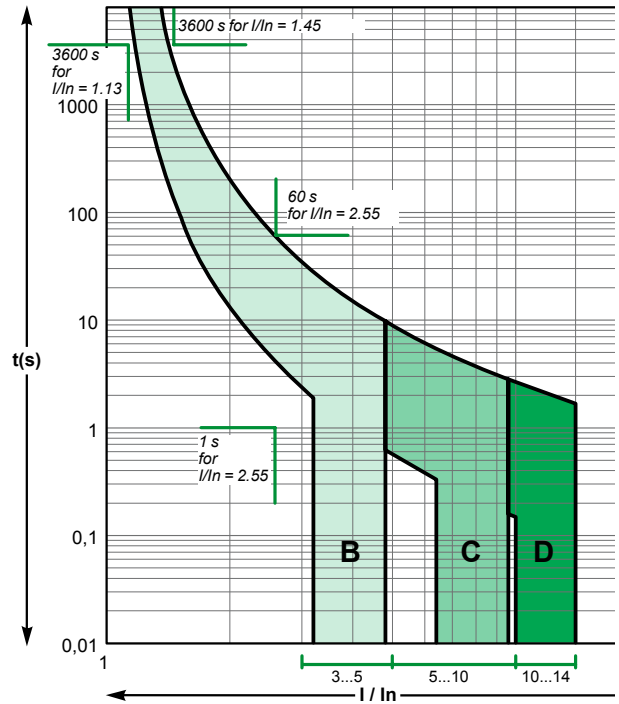

Direct current

C60H-DC

According to IEC/EN 60947-2 (reference temperature 25°C)

Curve C

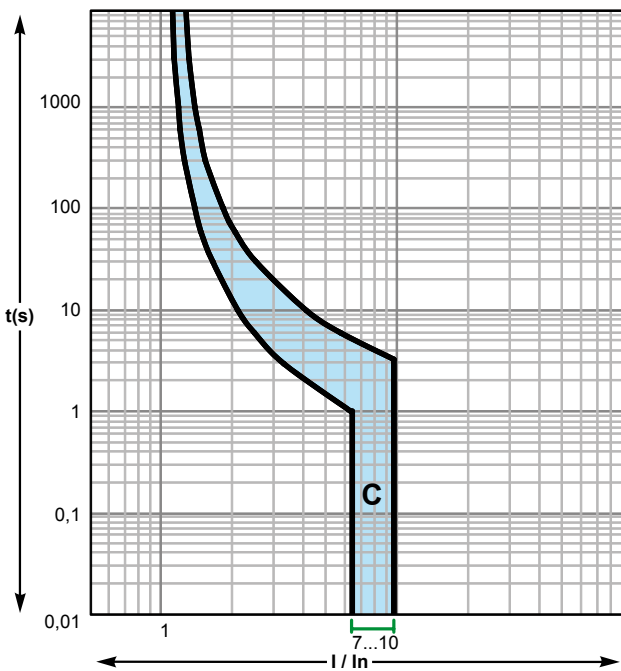

Alternative current 50/60 Hz

Reflex iC60N/H

According to IEC/EN 60947-2 (reference temperature 50°C)

Curves B, C, D

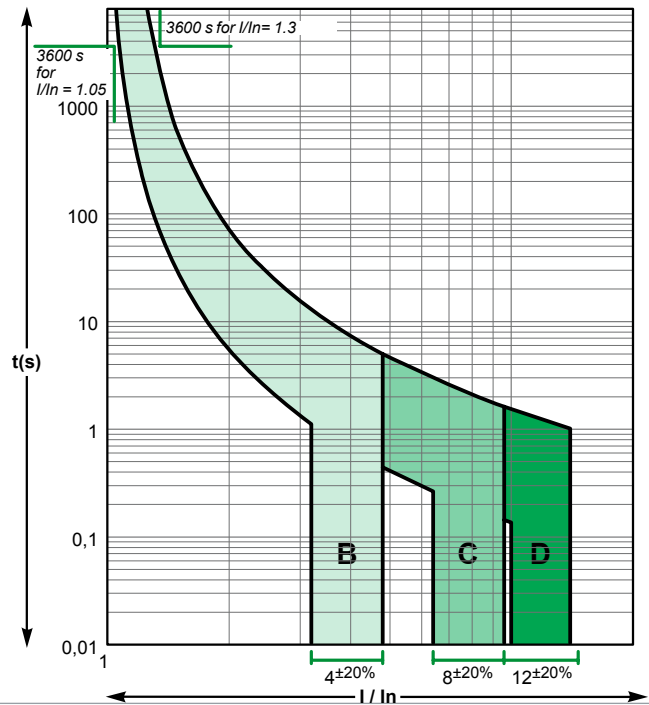

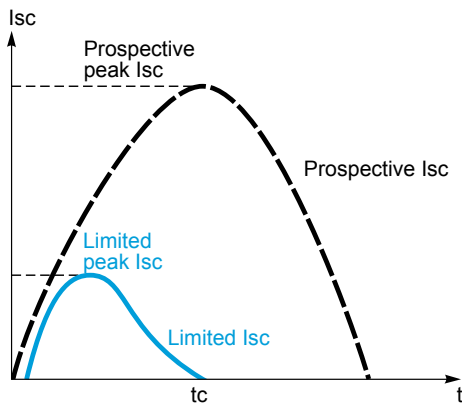

Prospective current and real limit current.

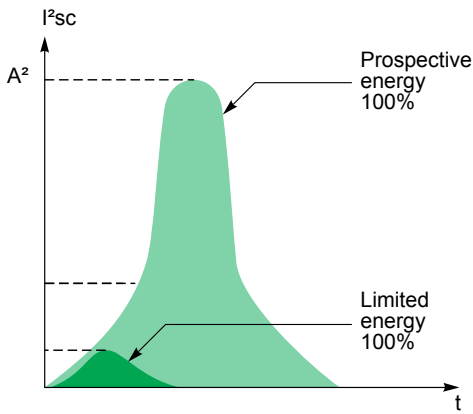

Definition

The limiting capacity of a circuit breaker is its ability to lessen the effects of a short circuit on an electrical installation by reducing the current amplitude and the dissipated power.

Benefits of limiting

Long installation service life

Thermal effects

Lower temperature rise at the conductor level, hence increased service life for cables and all components that are not self-protected (e.g. switches, contactors, etc.)

Mechanical effects

Lower electrodynamic repulsion forces, hence less risk of deformation or breakage of electrical contacts and busbars.

Electromagnetic effects

Less interference on sensitive equipment located in the vicinity of an electric circuit.

Savings through cascading

Cascading is a technique derived directly from current limiting: downstream of a current-limiting circuit breaker it is possible to use circuit breakers of breaking capacity lower than the prospective short-circuit current (in line with the cascading tables). The breaking capacity is heightened thanks to current limiting by the upstream device. Substantial savings can be achieved in this way on switchgear and enclosures.

Discrimination of protection devices

The circuit breakers' current limiting capacity improves discrimination with the protection devices located upstream: this is because the required energy passing through the upstream protection device is greatly reduced and can be not enough to cause it to trip. Discrimination can thus be natural without having to install a time-delayed protection device upstream.

Acti 9 circuit breaker current limiting

Profiting from Schneider Electric's experience and expertise in the field of shortcircuit current breaking, the circuit breakers of the Acti 9 range have a top-level current limiting characteristic for modular devices.

This assures them of optimal protection of the entire power distribution system.

Representation: Current limiting curves

The current limiting capacity of a circuit breaker is reflected by 2 curves which give, as a function of the prospective short-circuit current (current which would flow in the absence of a protection device):

- the real peak current (limited)
- the thermal stress (in A s), this value, multiplied by the resistance of any element through which the short-circuit current passes, gives the power dissipated by this element. The straight line «10 ms» representing the energy A s of a prospective short-circuit current of a half-period (10 ms) indicates the energy that would be dissipated by the short-circuit current in the absence of limiting by the protection device (see example).

Example

What is the energy limited by an iC60N 25 A circuit breaker for a prospective short-circuit current of 10 kA rms. What is the quality of current limiting?

> as shown in the graph opposite:

- this short-circuit current (10 kA rms) is likely to dissipate up to 1,000 kA²s
- the iC60N circuit breaker reduces this thermal stress to: 45 kA²s, which is 22 times less.

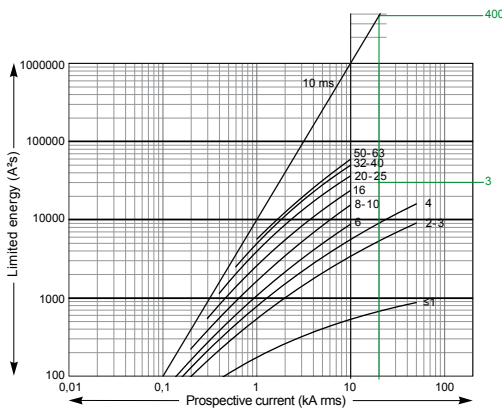

Example of use: Stresses acceptable by the cables

The following table shows the thermal stresses acceptable by the cables depending on their insulation, their composition (Cu or Al) and their cross section. Cross-section values are expressed in mm² and stresses in A s.

S (mm ²)		1.5	2.5	4	6	10
PVC	Cu	2.97 x 10 ⁴	8.26 x 10 ⁴	2.12 x 10 ⁵	4.76 x 10 ⁵	1.32 x 10 ⁶
	Al					5.41 x 10 ⁵
PRC	Cu	4.10 x 10 ⁴	1.39 x 10 ⁵	2.92 x 10 ⁵	6.56 x 10 ⁵	1.82 x 10 ⁶
	Al					7.52 x 10 ⁵

S (mm ²)		16	25	35	50
PVC	Cu	3.4 x 10 ⁶	8.26 x 10 ⁶	1.62 x 10 ⁷	3.21 x 10 ⁷
	Al	1.39 x 10 ⁶	3.38 x 10 ⁶	6.64 x 10 ⁶	1.35 x 10 ⁷
PRC	Cu	4.69 x 10 ⁶	1.39 x 10 ⁷	2.23 x 10 ⁷	4.56 x 10 ⁷
	Al	1.93 x 10 ⁶	4.70 x 10 ⁶	9.23 x 10 ⁶	1.88 x 10 ⁷

Example

Is a Cu/PVC cable of cross section 10 mm² protected by a NG125L device?

The above table shows that the acceptable stress is 1.32 x 10⁶ A s. Any short-circuit current at the point where a NG125L device (I_{cu} = 25 kA) is installed will be limited, with a thermal stress of less than 2.2 x 10⁵ A s. (Curve on page 280 - 281).

The cable is therefore always protected up to the breaking capacity of the circuit breaker.

Limitation curves for network

U_e: 220-240 V AC (Ph/N 110-130 V AC)

xC60

1P / 1P+N
Peak current

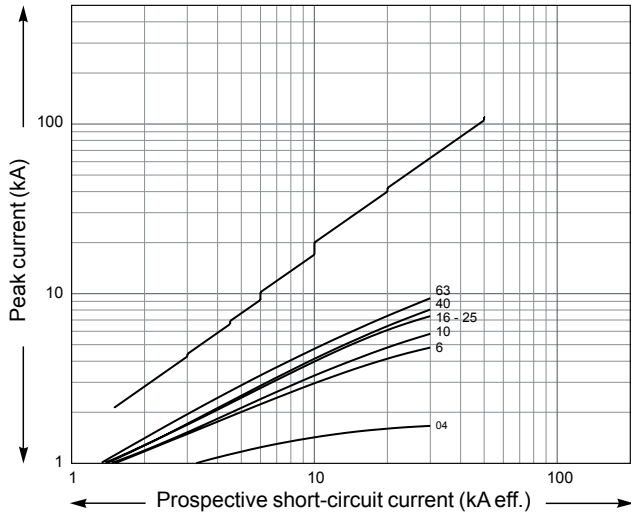

Thermal stress

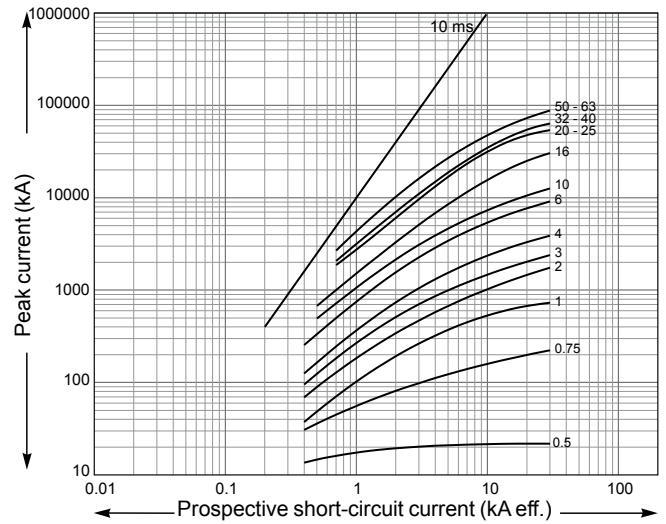

Limitation curves for network

U_e: 380-415 V AC (Ph/N 220-240 V AC)

xC60

2P / 3P / 4P
Peak current

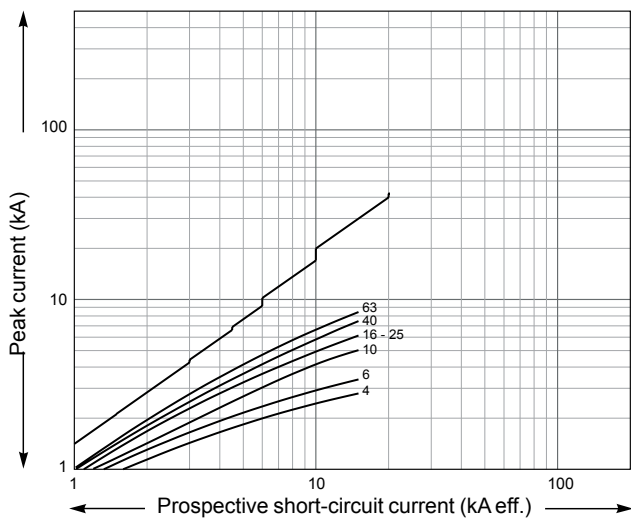

Thermal stress

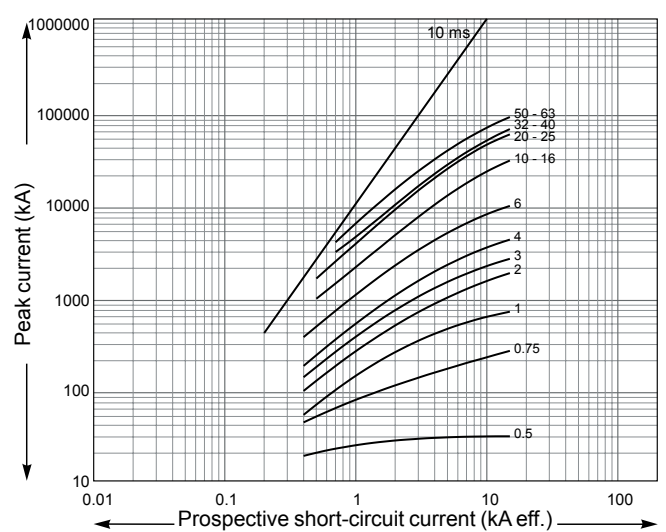

Limitation curves for network

Ue: 440 V AC

xC60

2P / 3P / 4P
Peak current

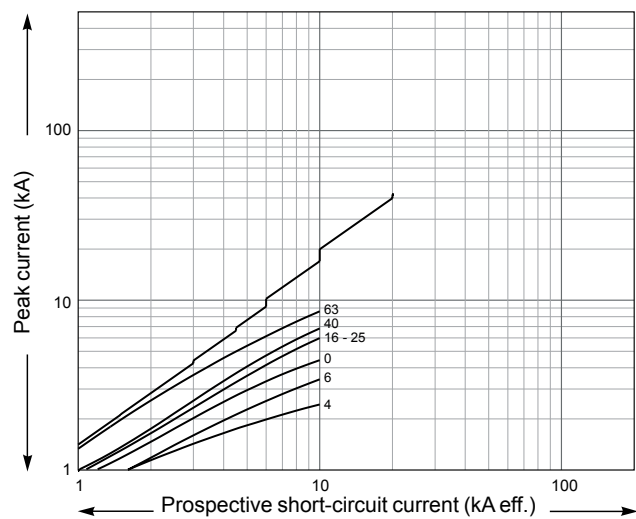

Thermal stress

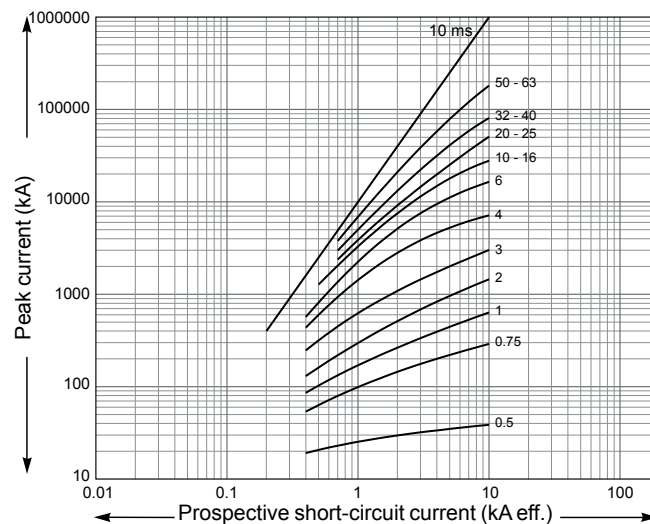

Control & Indication Devices

Communication Ready Devices

General comment

Modular contactors and impulse relays do not use the same technologies. Their rating is determined according to different standards and does not correspond to the rated current of the circuit.

For example, for a given rating, an impulse relay is more efficient than a modular contactor for the control of light fittings with a strong inrush current, or with a low power factor (non-compensated inductive circuit).

Relay rating

■ The table below shows the maximum number of light fittings for each relay, according to the type, power and configuration of a given lamp. As an indication, the total acceptable power is also mentioned.

■ These values are given for a 230 V circuit with 2 active conductors (single-phase phase/neutral or two-phase phase/phase). For 110 V circuits, divide the values in the table by 2.

■ To obtain the equivalent values for the entire 230 V three-phase circuit, multiply the number of lamps and the maximum power output:

□ by $\sqrt{3}$ (1.73) for circuits with 230 V between phases without neutral;

□ by $\sqrt{3}$ for circuits with 230 V between phase and neutral or 400 V between phases.

Note: The power ratings of the lamps most commonly used are shown in bold. For powers not mentioned, use a proportional rule with the nearest values.

Choice table

Products		iTL impulse relays		iCT contactors										
Type of lamp	Unit power and capacitance of power factor correction capacitor	Maximum number of light fittings for a single-phase circuit and maximum power output per circuit												
		16 A		32 A		16 A		25 A		40 A		63/100 A		
Basic incandescent lamps, LV halogen lamps, replacement mercury vapour lamps (without ballast)														
	40 W	40	1500 W	106	4000 W	38	1500 W	57	2300 W	115	4600 W	172	6900 W	
	60 W	25	to	66	to	30	to	45	to	85	to	125	to	
	75 W	20	1600 W	53	4200 W	25	2000 W	38	2850 W	70	5250 W	100	7500 W	
	100 W	16		42		19		28		50		73		
	150 W	10		28		12		18		35		50		
	200 W	8		21		10		14		26		37		
	300 W	5	1500 W	13	4000 W	7	2100 W	10	3000 W	18	5500 W	25	7500 W	
	500 W	3		8		4		6		10	to	15	to	
	1000 W	1		4		2		3		6	6000 W	8	8000 W	
	1500 W	1		2		1		2		4		5		
ELV 12 or 24 V halogen lamps														
With ferromagnetic transformer	20 W	70	1350 W	180	3600 W	15	300 W	23	450 W	42	850 W	63	1250 W	
	50 W	28	to	74	to	10	to	15	to	27	to	42	to	
	75 W	19	1450 W	50	3750 W	8	600 W	12	900 W	23	1950 W	35	2850 W	
	100 W	14		37		6		8		18		27		
With electronic transformer	20 W	60	1200 W	160	3200 W	62	1250 W	90	1850 W	182	3650 W	275	5500 W	
	50 W	25	to	65	to	25	to	39	to	76	to	114	to	
	75 W	18	1400 W	44	3350 W	20	1600 W	28	2250 W	53	4200 W	78	6000 W	
	100 W	14		33		16		22		42		60		
Fluorescent tubes with starter and ferromagnetic ballast														
1 tube without compensation ⁽¹⁾	15 W	83	1250 W	213	3200 W	22	330 W	30	450 W	70	1050 W	100	1500 W	
	18 W	70	to	186	to	22	to	30	to	70	to	100	to	
	20 W	62	1300 W	160	3350 W	22	850 W	30	1200 W	70	2400 W	100	3850 W	
	36 W	35		93		20		28		60		90		
	40 W	31		81		20		28		60		90		
	58 W	21		55		13		17		35		56		
	65 W	20		50		13		17		35		56		
	80 W	16		41		10		15		30		48		
	115 W	11		29		7		10		20		32		
1 tube with parallel compensation ⁽²⁾	15 W	5 µF	60	900 W	160	2400 W	15	200 W	20	300 W	40	600 W	60	900 W
	18 W	5 µF	50		133		15	to	20	to	40	to	60	to
	20 W	5 µF	45		120		15	800 W	20	1200 W	40	2400 W	60	3500 W
	36 W	5 µF	25		66		15		20		40		60	
	40 W	5 µF	22		60		15		20		40		60	
	58 W	7 µF	16		42		10		15		30		43	
	65 W	7 µF	13		37		10		15		30		43	
	80 W	7 µF	11		30		10		15		30		43	
	115 W	16 µF	7		20		5		7		14		20	
2 or 4 tubes with series compensation	2 x 18 W		56	2000 W	148	5300 W	30	1100 W	46	1650 W	80	2900 W	123	4450 W
	4 x 18 W		28		74		16	to	24	to	44	to	68	to
	2 x 36 W		28		74		16	1500 W	24	2400 W	44	3800 W	68	5900 W
	2 x 58 W		17		45		10		16		27		42	
	2 x 65 W		15		40		10		16		27		42	
	2 x 80 W		12		33		9		13		22		34	
	2 x 115 W		8		23		6		10		16		25	

Control & Indication Devices

Communication Ready Devices

Choice table (cont.)

Products		iTL impulse relays		iCT contactors										
Type of lamp	Unit power and capacitance of power factor correction capacitor	Maximum number of light fittings for a single-phase circuit and maximum power output per circuit												
		16 A	32 A	16 A	25 A	40 A	63/100 A							
Fluorescent tubes with electronic ballast														
1 or 2 tubes	18 W	80	1450 W	212	3800 W	74	1300 W	111	2000 W	222	4000 W	333	6000 W	
	36 W	40	to	106	to	38	to	58	to	117	to	176	to	
	58 W	26	1550 W	69	4000 W	25	1400 W	37	2200 W	74	4400 W	111	6600 W	
	2 x 18 W	40		106		36		55		111		166		
	2 x 36 W	20		53		20		30		60		90		
	2 x 58 W	13		34		12		19		38		57		
Compact fluorescent lamps														
With external electronic ballast	5 W	240	1200 W	630	3150 W	210	1050 W	330	1650 W	670	3350 W	Not tested		
	7 W	171	to	457	to	150	to	222	to	478	to			
	9 W	138	1450 W	366	3800 W	122	1300 W	194	2000 W	383	4000 W			
	11 W	118		318		104		163		327				
	18 W	77		202		66		105		216				
	26 W	55		146		50		76		153				
With integral electronic ballast (replacement for incandescent lamps)	5 W	170	850 W	390	1950 W	160	800 W	230	1150 W	470	2350 W	710	3550 W	
	7 W	121	to	285	to	114	to	164	to	335	to	514	to	
	9 W	100	1050 W	233	2400 W	94	900 W	133	1300 W	266	2600 W	411	3950 W	
	11 W	86		200		78		109		222		340		
	18 W	55		127		48		69		138		213		
	26 W	40		92		34		50		100		151		
High-pressure mercury vapour lamps with ferromagnetic ballast without ignitor														
Replacement high-pressure sodium vapour lamps with ferromagnetic ballast with integral ignitor (3)														
Without compensation ⁽¹⁾	50 W	Not tested, infrequent use			15	750 W	20	1000 W	34	1700 W	53	2650 W		
	80 W				10	to	15	to	27	to	40	to		
	125 / 110 W ⁽³⁾				8	1000 W	10	1600 W	20	2800 W	28	4200 W		
	250 / 220 W ⁽³⁾				4		6		10		15			
	400 / 350 W ⁽³⁾				2		4		6		10			
	700 W				1		2		4		6			
With parallel compensation ⁽²⁾	50 W	7 µF			10	500 W	15	750 W	28	1400 W	43	2150 W		
	80 W	8 µF			9	to	13	to	25	to	38	to		
	125 / 110 W ⁽³⁾	10 µF			9	1400 W	10	1600 W	20	3500 W	30	5000 W		
	250 / 220 W ⁽³⁾	18 µF			4		6		11		17			
	400 / 350 W ⁽³⁾	25 µF			3		4		8		12			
	700 W	40 µF			2		2		5		7			
1000 W	60 µF			0		1		3		5				
Low-pressure sodium vapour lamps with ferromagnetic ballast with external ignitor														
Without compensation ⁽¹⁾	35 W	Not tested, infrequent use			5	270 W	9	320 W	14	500 W	24	850 W		
	55 W				5	to	9	to	14	to	24	to		
	90 W				3	360 W	6	720 W	9	1100 W	19	1800 W		
	135 W				2		4		6		10			
	180 W				2		4		6		10			
With parallel compensation ⁽²⁾	35 W	20 µF	38	1350 W	102	3600 W	3	100 W	5	175 W	10	350 W	15	550 W
	55 W	20 µF	24		63		3	to	5	to	10	to	15	to
	90 W	26 µF	15		40		2	180 W	4	360 W	8	720 W	11	1100 W
	135 W	40 µF	10		26		1		2		5		7	
	180 W	45 µF	7		18		1		2		4		6	

Control & Indication Devices

Communication Ready Devices

Choice table (cont.)

Products		iTL impulse relays		iCT contactors			
Type of lamp	Unit power and capacitance of power factor correction capacitor	Maximum number of light fittings for a single-phase circuit and maximum power output per circuit					
		16 A	32 A	16 A	25 A	40 A	63/100 A
High-pressure sodium vapour lamps Metal-iodide lamps							
With ferromagnetic ballast with external ignitor, without compensation ⁽¹⁾	35 W 70 W 150 W 250 W 400 W 1000 W	Not tested, infrequent use		16 600 W 8 4 2 1 0	24 850 W 12 to 7 1200 W 4 3 1	42 1450 W 20 to 13 2000 W 8 5 2	64 2250 W 32 to 18 3200 W 11 8 3
With ferromagnetic ballast with external ignitor and parallel compensation ⁽²⁾	35 W 6 µF 70 W 12 µF 150 W 20 µF 250 W 32 µF 400 W 45 µF 1000 W 60 µF 2000 W 85 µF	34 1200 W 17 to 8 1350 W 5 3 1 0	88 3100 W 45 to 22 3400 W 13 8 3 1 1	12 450 W 6 to 4 1000 W 3 2 1 0	18 650 W 9 to 6 2000 W 4 3 2 1	31 1100 W 16 to 10 4000 W 7 5 3 2	50 1750 W 25 to 15 6000 W 10 7 5 3
With electronic ballast	35 W 70 W 150 W	38 1350 W 29 to 14 2200 W	87 3100 W 77 to 33 5000 W	24 850 W 18 to 9 1350 W	38 1350 W 29 to 14 2200 W	68 2400 W 51 to 26 4000 W	102 3600 W 76 to 40 600 W

- (1) Circuits with non-compensated ferromagnetic ballasts consume twice as much current for a given lamp power output. This explains the small number of lamps in this configuration.
- (2) The total capacitance of the power factor correction capacitors in parallel in a circuit limits the number of lamps that can be controlled by a contactor. The total downstream capacitance of a modular contactor of rating 16, 25, 40 or 63 A should not exceed 75, 100, 200 or 300 µF respectively. Allow for these limits to calculate the maximum acceptable number of lamps if the capacitance values are different from those in the table.
- (3) High-pressure mercury vapour lamps without ignitor, of power 125, 250 and 400 W, are gradually being replaced by high-pressure sodium vapour lamps with integral ignitor, and respective power of 110, 220 and 350 W.

Control & Indication Devices

Communication Ready Devices

Heating application

■ Impulse relay rating to be chosen according to the power to be controlled.

230 V heating		
Type	Maximum power for a given rating iTL impulse relays	
Single-phase circuit	16 A	32 A
Heating (AC1)	3.6 kW	7.2 kW

■ Contactor rating to be chosen according to the power to be controlled and the number of operations a day.

230 V heating				
Type of heating application	Maximum power for a given rating iCT contactors			
Number of operations / day	25 A	40 A	63 A	100 A
25	5.4 kW	8.6 kW	14 kW	21.6 kW
50	5.4 kW	8.6 kW	14 kW	21.6 kW
75	4.6 kW	7.4 kW	12 kW	18 kW
100	4 kW	6 kW	9.5 kW	14 kW
250	2.5 kW	3.8 kW	6 kW	9 kW
500	1.7 kW	2.7 kW	4.5 kW	6.8 kW

400 V heating				
25	16 kW	26 kW	41 kW	63 kW
50	16 kW	26 kW	41 kW	63 kW
75	14 kW	22 kW	35 kW	52 kW
100	11 kW	17 kW	26 kW	40 kW
250	5 kW	8 kW	13 kW	19 kW
500	3.5 kW	6 kW	9 kW	14 kW

Small motor application

Contactor rating to be chosen according to the power to be controlled.

Asynchronous single-phase motor with capacitor			
Small motor application type	Maximum power for a given rating iCT contactors		
Voltage	25 A	40 A	63 A
230 V	1.4	2.5	4

Asynchronous three-phase motor			
400 V	4	7.5	15

Universal motor			
230 V	0.9	1.4	2.2

Control & Indication Devices

Basic Control & Indication

Switches

■ In all cases, the switches are correctly protected against overloads by a circuit breaker with a lower or equal rating, operating at the same ambient temperature.

iCT contactors

In the case of contactor mounting in an enclosure for which the interior temperature is in a range between 50°C and 60°C, it is necessary to use a spacer, cat. no. A9A27062, between each contactor.

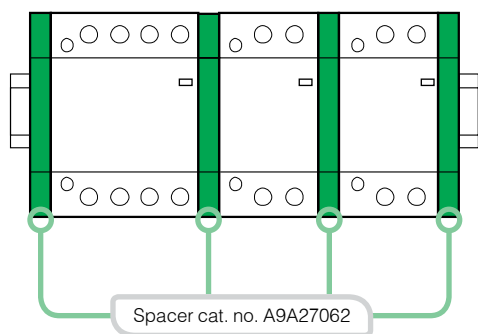

Splitter blocks

In the event of a temperature higher than 40°C, the maximum acceptable current is limited to the values in the table below:

Type	Temperature				
	40°C	45°C	50°C	55°C	60°C
Multiclip 80 A	80	76	73	69	66
Distribloc 63 A	63	60	58	55	53

Protection discrimination is an essential element that must be taken into account starting at the design stage of a low voltage installation to ensure the highest level of availability for users.

Discrimination is important in all installations for the comfort of users, however it is fundamental in installations requiring a high level of service continuity, e.g. industrial manufacturing processes.

Industrial installations without discrimination run a series of risks of varying importance including:

- production deadline overruns
- interruption in manufacturing, entailing:
 - production or finished-product losses
 - risk of damage to production machines in continuous processes
- restarting of machines, one by one, following a general power outage
- shutdown of vital safety equipment such as lubrication pumps, smoke fans, etc.

What is discrimination?

Discrimination, also called selectivity, is the coordination of automatic protection devices in such a manner that a fault appearing at a given point in a network is cleared by the protection device installed immediately upstream of the fault, and by that device alone.

■ **total discrimination**

Discrimination is said to be total if, for all fault current values, from overloads up to the non-resistive short-circuit current, circuit breaker D2 opens and D1 remains closed.

■ **partial discrimination**

Discrimination is partial if the above condition is not respected up to the full short-circuit current, but only to a lesser value termed the selectivity limit current (I_s).

■ **no discrimination**

In the event of a fault, both circuit breakers D1 and D2 open.

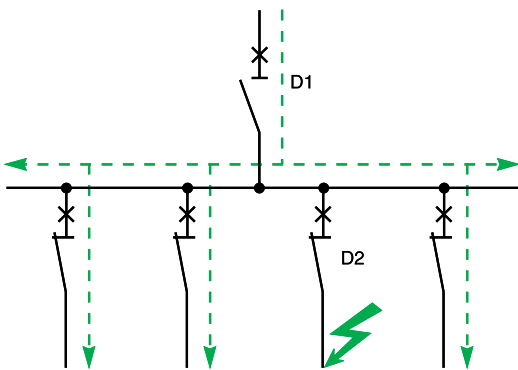

Total discrimination as standard with Masterpact NT/NW circuit breakers

Thanks to their highly innovative design and the exceptional performance of their control units, the Masterpact NT and NW circuit breakers offer total discrimination with downstream Compact NSX devices up to 630 A as standard (1).

Natural discrimination with Compact NSX circuit breakers

Due to the Roto-active breaking technique employed by the Compact NSX, the combined use of Schneider Electric circuit breakers provides an exceptional level of protection discrimination.

This is the result of the implementation and optimisation of three different techniques:

- current discrimination
- time discrimination
- energy discrimination.

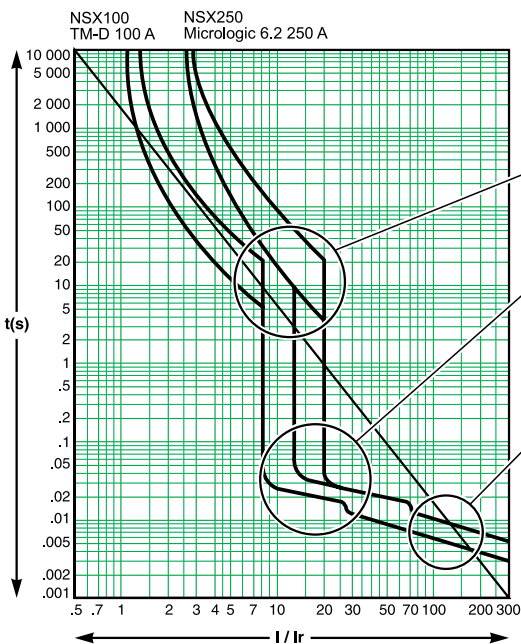

Overload protection: current discrimination

Discrimination is ensured if the ratio between setting thresholds is greater than 1.6 (for distribution circuit breakers).

Low short-circuit protection: current discrimination.

Tripping of the upstream device is slightly delayed to ensure that the downstream device trips first.

Discrimination is ensured if the ratio between the short-circuit thresholds is greater than 1.5. High short-circuit protection: time discrimination.

This protection system combines the exceptional current limiting capacity of the Compact NS and the advantages of reflex tripping, sensitive to the energy dissipated in the device by the short-circuit. In the event of a high short-circuit detected by two circuit breakers, the downstream device limits it sharply. The energy dissipated in the upstream device is not sufficient to trip it, i.e. discrimination is total for all short-circuit currents.

Discrimination is ensured if the ratio between the circuit breaker ratings is greater than 2.

(1) Except for the L1 performance level on Masterpact NT and subject to the discrimination rules on page 558E4300/7.

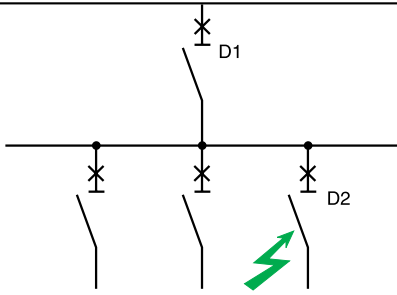

Discrimination between two distribution circuit breakers.

How to use the discrimination tables

- for discrimination between 2 distribution circuit breakers

Combinations providing full discrimination are indicated by the symbol T. If discrimination is partial, the table indicates the maximum fault current value for which discrimination is ensured. For fault currents above this value, the 2 circuit breakers trip simultaneously.

Requisite conditions

The values indicated in the tables are valid for operational rated voltages of 220, 380, 415 and 440V:

Upstream	Downstream	Frame up / Frame down	Thermal protection I _{r up} /I _{r down}	Magnetic protection I _{m up} /I _{m down}
TM	TM or Multi 9	≥ 2.5	≥ 1.6	≥ 2
	Micrologic	≥ 2.5	≥ 1.6	≥ 1.5
Micrologic	TM or Multi 9	≥ 2.5	≥ 1.6	≥ 1.5
	Micrologic	≥ 2.5	≥ 1.3	≥ 1.5

These conditions ensure that curves don't overlap. Curves could also be checked with Curve Direct software tools

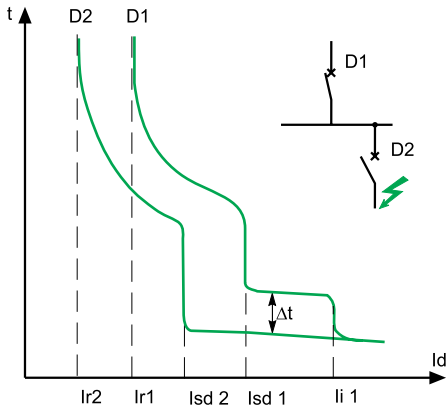

Additional Settings conditions according to trip unit type

- Short time pick up (I_{sd})
Tables indicate selectivity limits assuming I_{sd} = 10 x I_r. In many cases when discrimination is Total lower thresholds could be used if ratio condition between two magnetic protections is fulfilled. When selectivity limit indicated in the tables is equal to 10xI_r, the selectivity limit is upstream short time pick up (I_{sd}).
- Instantaneous pick up (I_{li})
Tables indicate selectivity limits assuming instantaneous pick up is set at the maximum value and when it's inhibited (Type B Circuit breaker only). With Masterpact, when selectivity limit indicated in the tables is equal to 15 x I_n, the selectivity limit is upstream instantaneous pick up (I_{li}). When upstream circuit Breaker is A type, and downstream circuit breaker is B type upstream instantaneous setting can be set lower than 15 I_n as far as it stay higher than downstream circuit breaker reflex tripping limit. When a Micrologic 5.x is used downstream a Micrologic 2.x Tsd shall be set at 0 and I_{li} shall be set at I_{sd}.

- Short time delay (T_{sd})
When upstream and downstream breaker are equipped with Micrologic 5.x, 6.x, 7.x: the minimum non tripping-time of the upstream device must be greater than the maximum tripping time of the downstream device.

T_{sd} D1 > T_{sd} D2 (One Step)

- I_{2t} Off / On

Tables indicate selectivity limits assuming I_{2t} Function is Off. If I_{2t} function is ON user shall check curves.

- Ground Fault protection (I_g, T_g)

When upstream and downstream breaker are equipped with Micrologic 6.x, user should implement current and time discrimination:

- current sensing discrimination

Threshold setting of upstream GFP device tripping is greater than that of the downstream GFP device. Because of tolerances on the settings, a 30 % difference between the upstream and downstream thresholds is sufficient.

- time graded discrimination

The intentional time delay setting of the upstream GFP device is greater than the opening time of the downstream device. Furthermore, the intentional time delay given to the upstream device must respect the maximum time for the elimination of insulation faults defined by the NEC § 230.95 (i.e. 1s for 3000 A).

I_g D1 ≥ 1,3 I_g D2 T_g D1 > T_g D2 (One Step)

- Earth Leakage Protection (I_Δ, T_Δ)

When upstream and downstream breaker are equipped with Micrologic 7.x or Vigi user should implement current and time discrimination:

current condition:

The RCD must trip between I_Δ and I_Δ/2, I_n where I_n is the declared operating current. There must therefore exist a minimum ratio of 2 between the sensitivities of the upstream device and the downstream device. In practice, the standardised values indicate a ratio of 3.

time condition:

The minimum non-tripping time of the upstream device must be greater than the maximum tripping time of the downstream device for all current values.

I_{Δn} D1 ≥ 3 x I_{Δn} D2 Δt D1 > Δt D1 (One Step)

Note : The tripping time of RCDs must always be less than or equal to the time specified in the installation standards to guarantee protection of people against indirect contacts.

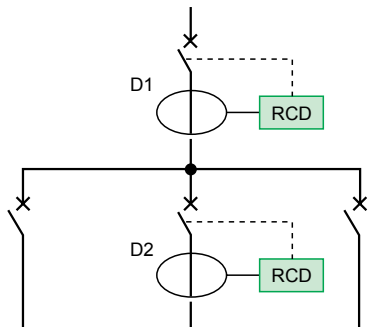
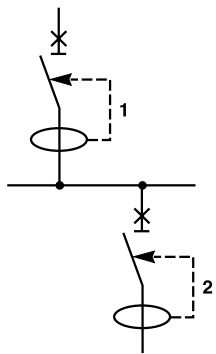

Compact NSX motor trip units

- Compact NSX Trip units dedicated to motor protection («M» type) can not be used to ensure discrimination with downstream circuit breaker.
- Furthermore Compact NSX trip unit dedicated to distribution should not be used to protect motors, even motors wit soft starter or speed drive.

Upstream: xC60, B curve

Downstream: xC60, B, C, D curves

Upstream		xC60 B curve											
In (A)		2	3	4	6	10	16	20	25	32	40	50	63
Downstream	Rating												
Discrimination limit (A)													
xC60	1			16	25	40	63	80	100	125	160	200	250
B Curve	2			16	25	40	63	80	100	125	160	200	250
	3				25	40	63	80	100	125	160	200	250
	4				25	40	63	80	100	125	160	200	250
	6					40	63	80	100	125	160	200	250
	10						63	80	100	125	160	200	250
	16								100	125	160	200	250
	20									125	160	200	250
	25										160	200	250
	32											200	250
	40												250
	50/63												
Discrimination limit (A)													
xC60	1			16	25	40	63	80	100	125	160	200	250
C Curve	2			16	25	40	63	80	100	125	160	200	250
	3				25	40	63	80	100	125	160	200	250
	4					40	63	80	100	125	160	200	250
	6						63	80	100	125	160	200	250
	10							80	100	125	160	200	250
	16									125	160	200	250
	20										160	200	250
	25											200	250
	32												250
	40												
	50/63												
Discrimination limit (A)													
xC60	1			16	25	40	63	80	100	125	160	200	250
D Curve	2				25	40	63	80	100	125	160	200	250
	3					40	63	80	100	125	160	200	250
	4						63	80	100	125	160	200	250
	6							80	100	125	160	200	250
	10									125	160	200	250
	16										160	200	250
	20											200	250
	25												250
	32												
	40												
	50/63												

400 Discrimination limit = 400 A.

No discrimination

Upstream: xC60, C curve

Downstream: xC60, B, C, D curves

Upstream		xC60 C curve												
In (A)		2	3	4	6	10	16	20	25	32	40	50	63	
Downstream	Rating													
Discrimination limit (A)														
xC60 B Curve	1			32	50	80	125	160	200	250	320	400	500	
	2			32	50	80	125	160	200	250	320	400	500	
	3				50	80	125	160	200	250	320	400	500	
	4				50	80	125	160	200	250	320	400	500	
	6					80	125	160	200	250	320	400	500	
	10						125	160	200	250	320	400	500	
	16							160	200	250	320	400	500	
	20								200	250	320	400	500	
	25									250	320	400	500	
	32										320	400	500	
	40											400	500	
	50/63												500	
	Discrimination limit (A)													
	xC60 C Curve	1			32	50	80	125	160	200	250	320	400	500
2				32	50	80	125	160	200	250	320	400	500	
3					50	80	125	160	200	250	320	400	500	
4					50	80	125	160	200	250	320	400	500	
6						80	125	160	200	250	320	400	500	
10							125	160	200	250	320	400	500	
16								160	200	250	320	400	500	
20									200	250	320	400	500	
25										250	320	400	500	
32											320	400	500	
40												400	500	
50/63													500	
Discrimination limit (A)														
xC60 D Curve		1			32	50	80	125	160	200	250	320	400	500
	2			32	50	80	125	160	200	250	320	400	500	
	3				50	80	125	160	200	250	320	400	500	
	4					80	125	160	200	250	320	400	500	
	6						125	160	200	250	320	400	500	
	10							160	200	250	320	400	500	
	16								200	250	320	400	500	
	20									250	320	400	500	
	25										320	400	500	
	32											400	500	
	40												500	
	50/63													

400 Discrimination limit = 400 A.

No discrimination

Note: respect the basic rules of discrimination, in terms of overcurrent, short-circuit, see page 6, or check curves with curve direct software.

Upstream: xC60, D curve

Downstream: xC60, B, C, D curves

Upstream		xC60 D curve												
In (A)		2	3	4	6	10	16	20	25	32	40	50	63	
Downstream	Rating													
Discrimination limit (A)														
xC60 B Curve	1			50	72	125	200	250	300	400	500	630	800	
	2			50	72	125	200	250	300	400	500	630	800	
	3				72	125	200	250	300	400	500	630	800	
	4				72	125	200	250	300	400	500	630	800	
	6					125	200	250	300	400	500	630	800	
	10						200	250	300	400	500	630	800	
	16								300	400	500	630	800	
	20									400	500	630	800	
	25										500	630	800	
	32											630	800	
	40												800	
	50/63													
	Discrimination limit (A)													
	xC60 C Curve	1			50	72	125	200	250	300	400	500	630	800
2				50	72	125	200	250	300	400	500	630	800	
3					72	125	200	250	300	400	500	630	800	
4					72	125	200	250	300	400	500	630	800	
6						125	200	250	300	400	500	630	800	
10							200	250	300	400	500	630	800	
16									300	400	500	630	800	
20										400	500	630	800	
25											500	630	800	
32												630	800	
40													800	
50/63														
Discrimination limit (A)														
xC60 D Curve		1			50	72	125	200	250	300	400	500	630	800
	2			50	72	125	200	250	300	400	500	630	800	
	3				72	125	200	250	300	400	500	630	800	
	4				72	125	200	250	300	400	500	630	800	
	6					125	200	250	300	400	500	630	800	
	10						200	250	300	400	500	630	800	
	16								300	400	500	630	800	
	20									400	500	630	800	
	25										500	630	800	
	32											630	800	
	40												800	
	50/63													

400 Discrimination limit = 400 A.

No discrimination

Technical Information

Protection discrimination

Upstream: C120, H, B Curve

Downstream: xC60, B, C, D curves

Upstream		C120H B curve										
In (A)		10	16	20	25	32	40	50	63	80	100	125
Downstream	Rating											
Discrimination limit (A)												
xC60	1	300	500	700	1000	1500	2000	2500	T	T	T	T
D Curve	2	150	300	500	700	1000	1500	2000	T	T	T	T
	3	40	63	300	500	700	1000	1500	T	T	T	T
	6		63	80	400	500	700	800	3000	T	T	T
	10				100	350	500	600	1800	3000	4000	T
	16						340	450	1000	2000	3300	3700
	20							200	1000	1600	2500	3700
	25								800	1300	2100	3700
	32									1000	1800	2700
	40										1600	2400

400 Discrimination limit = 400 A.

No discrimination

Note: respect the basic rules of discrimination, in terms of overcurrent, short-circuit, see page 6, or check curves with curve direct software.

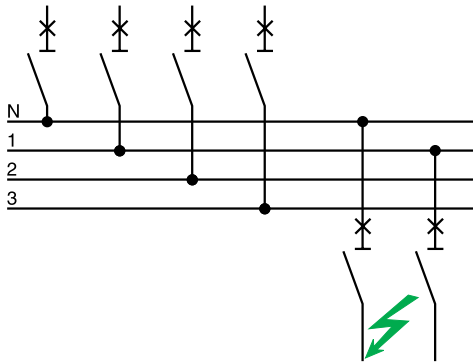

220/240 V network downstream from a 380/415 V network

For 1P + N or 2P circuit breakers connected between the phase and neutral on a 380/415 V network, with a TT or TNS neutral system, consult the 220/240 V cascading table to determinate cascading possibilities between upstream and downstream circuit breakers, for C60 upstream and consult the 380/415 V cascading table for iDPN.

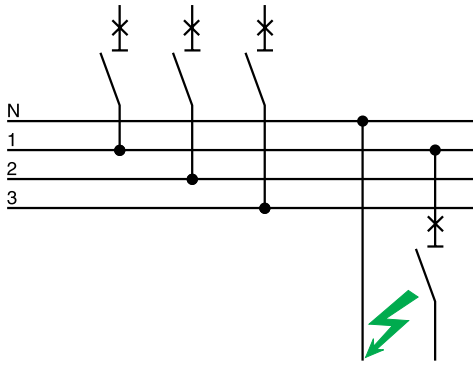

For 1P + N or 2P circuit breakers connected to one phase of a 380/415 V network used together with the neutral to supply a single-phase circuit, consult the cascading tables for 380/415 V networks to determine the cascading possibilities between upstream and downstream circuit breakers.

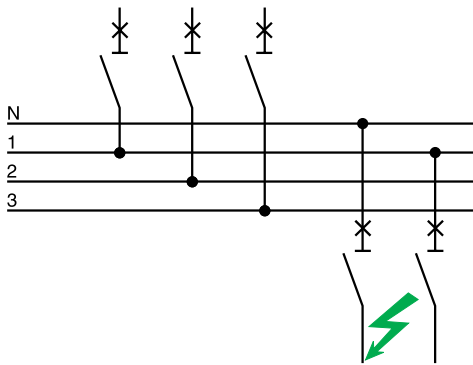

Example of three level cascading

Consider three circuit breakers A, B and C connected in series. The criteria for cascading are fulfilled in the following two cases:

- the upstream device A is coordinated for cascading with both devices B and C (even if the cascading criteria are not fulfilled between B and C). It is simply necessary to check that the combinations A + B and A + C have the required breaking capacity
 - each pair of successive devices is coordinated, i.e. A with B and B with C (even if the cascading criteria are not fulfilled between A and C). It is simply necessary to check that the combinations A + B and B + C have the required breaking capacity.
- The upstream breaker A is a NSX250L (breaking capacity 150 kA) for a prospective I_{sc} of 80 kA across its output terminals.
 A NSX100B (breaking capacity 25 kA) can be used for circuit breaker B for a prospective I_{sc} of 40 kA across its output terminals, since the «reinforced» breaking capacity provided by cascading with the upstream NSX250L is 50 kA.
 A C60H (breaking capacity 15 kA) can be used for circuit breaker C for a prospective I_{sc} of 24 kA across its output terminals since the «reinforced» breaking capacity provided by cascading with the upstream NSX250L is 25 kA.
 Note that the «reinforced» breaking capacity of the C60H with the NSX100B upstream is only 20 kA, but:
- A + B = 50 kA
 - A + C = 25 kA.

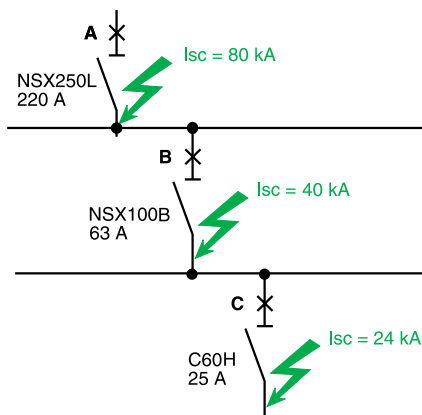

Technical Information

Cascading 220/240 V

Upstream: NSC100N

Compact NSX100-160

Downstream: xC60, C120

Upstream	NG160E	NG160N	NG160H	NSC100N	NSX100B	NSX100F	NSX100N	NSX100H	NSX100S	NSX100L
Breaking capacity (kA rms)	25	40	50	42	40	85	90	100	120	150
Downstream	Reinforced breaking capacity (kA rms)									
xC60		40	50	42	40	50	80	80	80	80
C120N		40	40	42	40	40	50	50	70	70
C120H		40	40	42	40	40	50	50	70	70

Upstream	NSX160B	NSX160F	NSX160N	NSX160H	NSX160S	NSX160L
Breaking capacity (kA rms)	40	85	90	100	120	150
Downstream	Reinforced breaking capacity (kA rms)					
xC60	40	50	80	80	80	80
C120N	40	40	50	50	70	70
C120H	40	40	50	50	70	70
NG160E	40	50	50	50	60	60

Cascading 220/240 V

Upstream: Compact NSX250

Downstream: xC60, C120

Upstream	NSX250B	NSX250F	NSX250N	NSX250H	NSX250S	NSX250L
Breaking capacity (kA rms)	40	85	90	100	120	150
Downstream	Reinforced breaking capacity (kA rms)					
xC60	40	50	65	65	65	65
C120N	40	40	50	50	70	70
C120H	40	40	50	50	70	70

Technical Information

Cascading, network 380/415 V

Upstream: xC60, C120, NG125

Downstream: xC60, C120

Upstream	C60H	32/40 A 20	50/63 15	C120N	C120H	NG125N	NG125H	NG125L
	15			10	15	25	36	50
Downstream	Breaking capacity (kA rms)							
xC60						25	36	36
C120N					15	25	25	36
C120H					15	25	25	35

Upstream: NSC100N

Compact NSX100-160

Downstream: xC60, C120

NSC100N, Compact NSX100-160

Upstream	NG160E	NG160N	NG160H	NSC100N	NSX100B	NSX100F	NSX100N	NSX100H	NSX100S	NSX100L
Breaking capacity (kA rms)	16	25	36	18	25	36	50	70	100	150
Downstream	Reinforced breaking capacity (kA rms)									
xC60	15	25	25	18	25	36	40	40	40	40
C120N		25	25	18	25	25	25	25	25	25
C120H		25	25	18	25	25	25	25	25	25

Upstream	NSX160B	NSX160F	NSX160N	NSX160H	NSX160S	NSX160L
Breaking capacity (kA rms)	25	36	50	70	100	150
Downstream						
xC60 ≤ 40 A	25	36	40	40	40	40
xC60 50 A and 63 A	25	30	30	30	30	30
C120N	25	25	25	25	25	25
C120H	25	25	25	25	25	25

Upstream	NSX250B	NSX250F	NSX250N	NSX250H	NSX250S	NSX250L
Breaking capacity (kA rms)	25	36	50	70	100	150
Downstream	Reinforced breaking capacity (kA rms)					
xC60 ≤ 40 A	25	30	30	30	30	30
xC60 50 A and 63 A	25	25	25	25	25	25
C120N	25	25	25	25	25	25
C120H	25	25	25	25	25	25



New
range of MCBs,
RCDs and DBs

Energy Efficiency from Power to Final Distribution

- > Up to 50% lesser power consumption compared to IEC Standards specification
- > Seamless connectivity to EMS and BMS by using Universal Modbus protocol
- > DB-mountable ComReady Meters metering energy usage from large sectors to individual loads

 EMC Certified



**Green
Products**

100% Recyclable
and Recoverable
REACH and RoHS
compliant

Target Segments and Applications

Targeted Segments

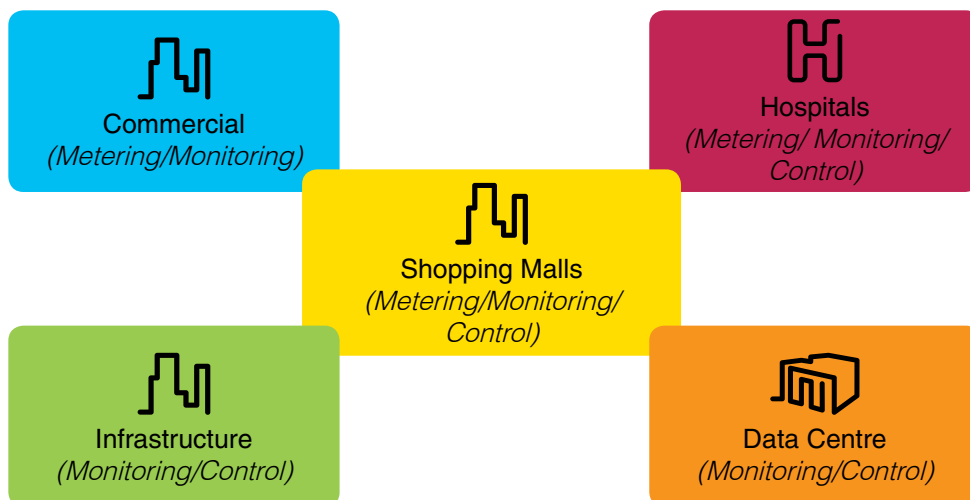

Applications:

- Data Centers
- Industrial premises
- Hospitals and Utilities
- Shopping Malls
- Commercial Establishments
- Residential townships

Benefits:

- Reduction in electricity expenses up to 15%
- Solution scalability
- Ensuring occupant comfort while reducing operating costs
- Can precisely locate the fault area
- Reliability of data and Indications

Monitoring and Control of each zone on centralized HMI via Modbus through Acti 9 Smartlink

Benefits

For users

- > Reduction in electricity expenses by up to 15% through management of lighting or other devices, by optimization related to human presence. The user can perfectly control energy consumption for each zone.
- > Solution scalability in the event of reallocation or addition of zones. The Acti 9 system allows fast, reliable changes to the wiring in the switchboard.
- > Ensuring occupant comfort while reducing operating costs, through last detection and pinpointing in the event of a malfunction on an electrical switchboard

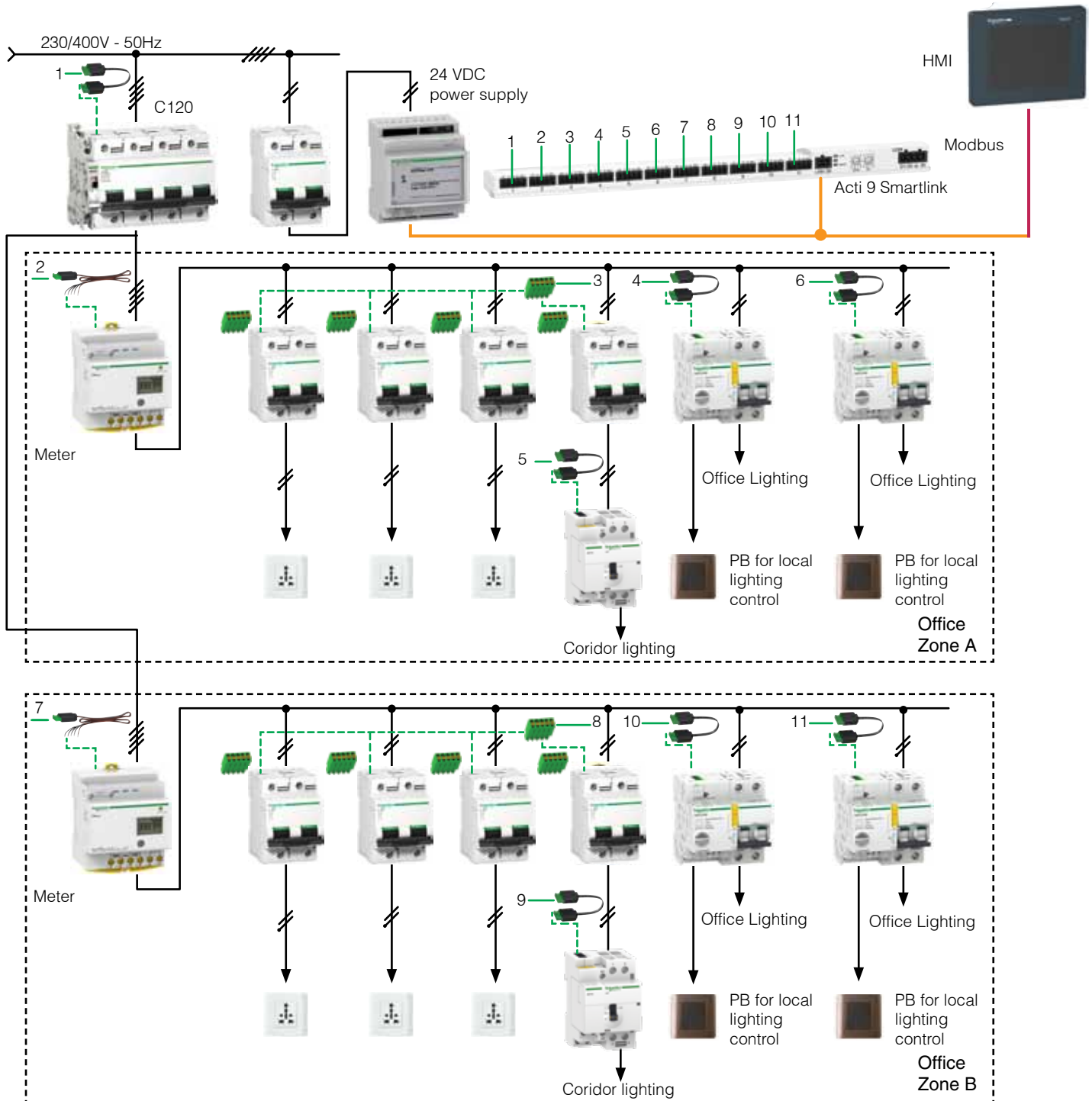

Status and control of individual load on centralized HMI via Ethernet through Acti 9 Smartlink and GSM Modem

Benefits

For the end user

Performance

- > The user is warned as soon as a protective device trips and he knows precisely where the fault is located.

Reliability of data and indications

- > Low-level signalling contacts complying with IEC 60947-5-4.
- > High level of electromagnetic compatibility of the Acti 9 Smartlink modules.

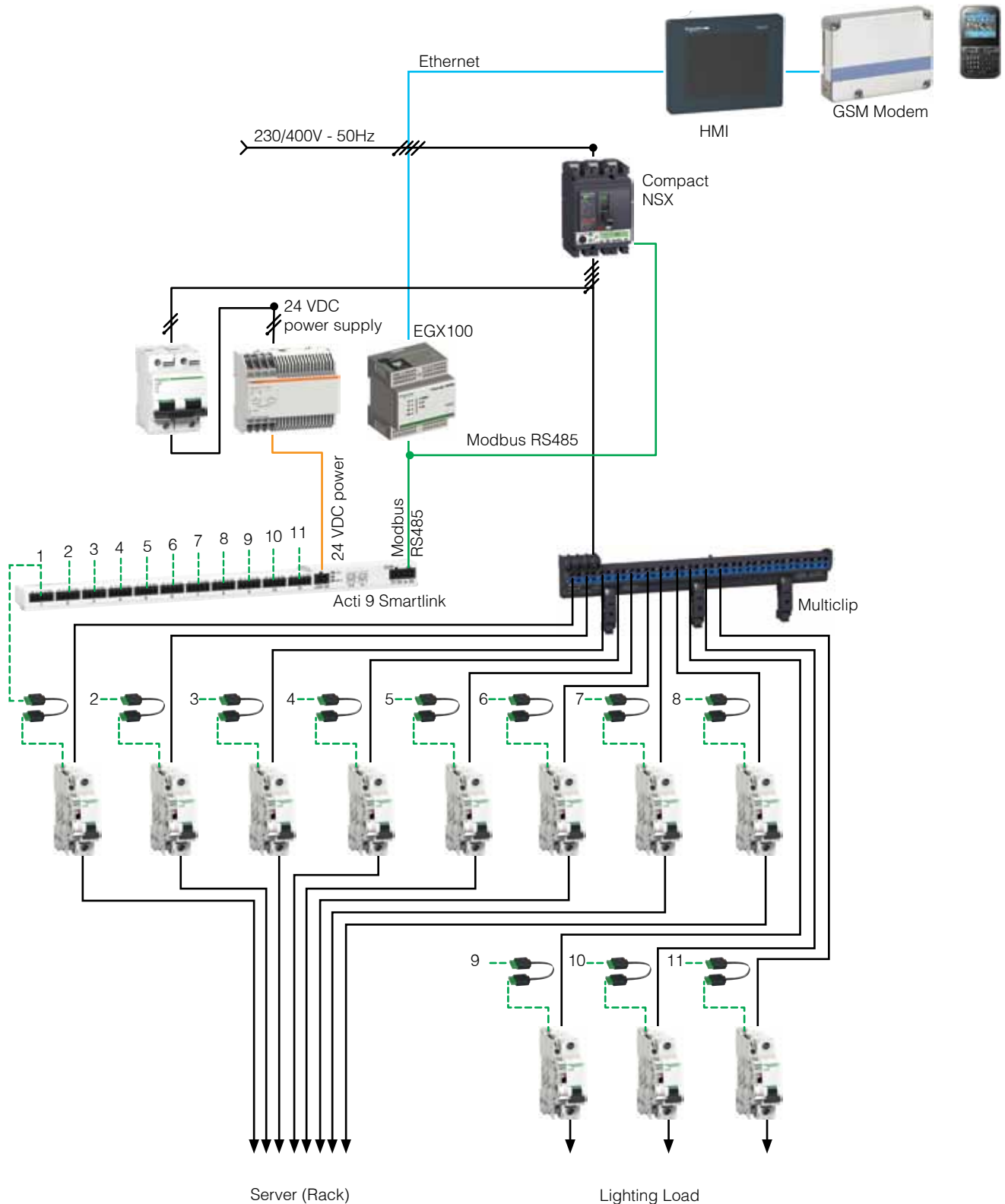

Status and control of individual load on centralized PC via Ethernet through Acti 9 Smartlink

Benefits

For users

- > Reduction in electricity expenses by up to 30% through supervision allowing targeted actions
- > Optimization of investment with a system designed and optimized for electricity distribution, handling all the functions useful for operation.

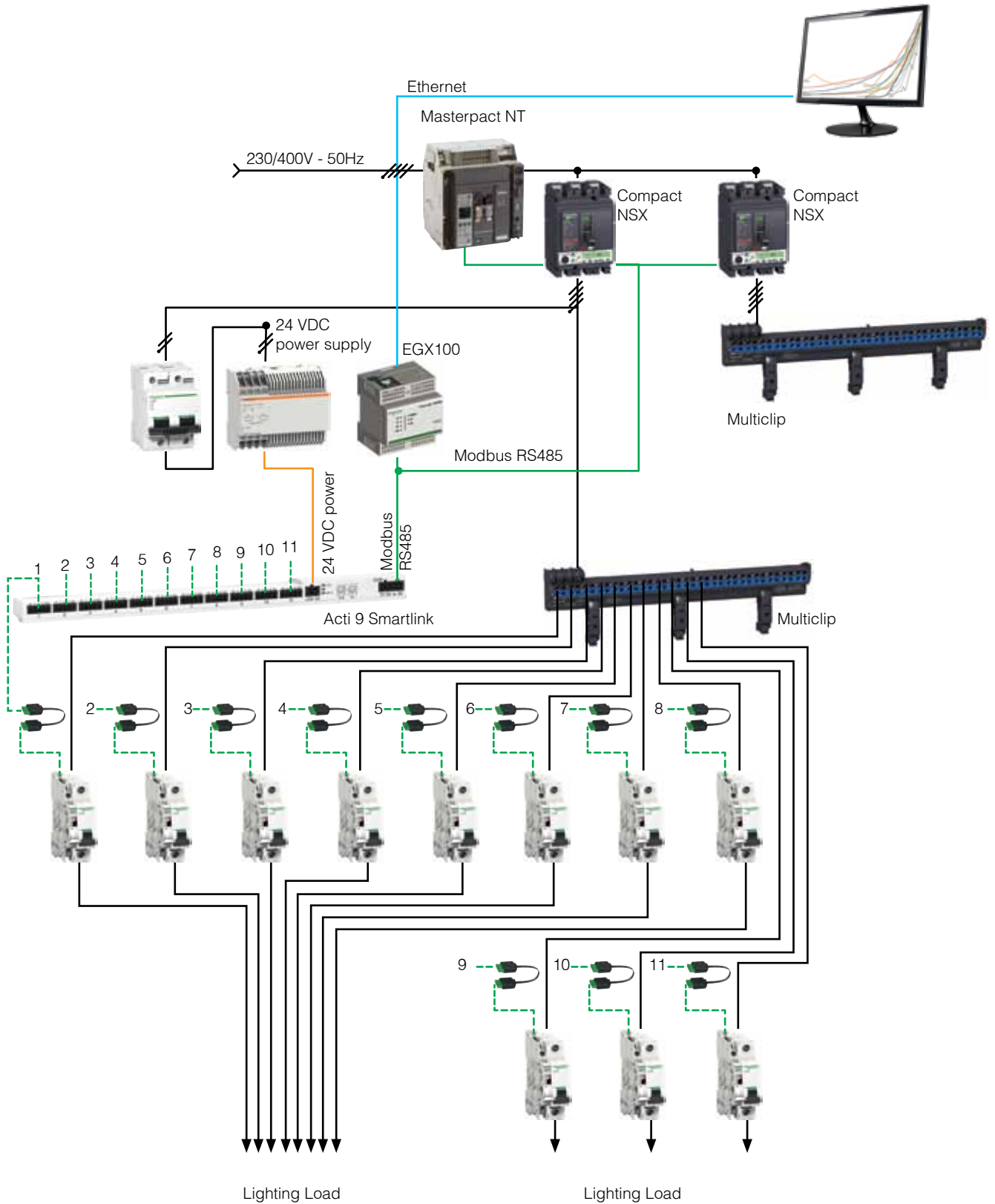

Make the most of your energy

Ahmedabad

Schneider Electric India (P) Ltd.
41 B, 42 A, 4th Floor, Space House
Opp. Sri Krishna Centre, Mithakall
Six Roads, Ahmedabad - 380009
Tel: 079-26440368/26426944
Fax: 079-26426948

Bangalore

Schneider Electric India (P) Ltd.
4th Floor, Electra, Wing 'A'
Exora Business Parks, Marathahalli,
Sarjapur Outer Ring Road,
Bangalore - 560 103.
Tel: 080-4333 3333,
Fax: 080-4333 2323

Chandigarh

Schneider Electric India (P) Ltd.
SCO. 13-14-15, 4th Floor, Sector-34-A
Chandigarh - 160022
Tel: 0172-5076781/82/83/84
Fax: 0172-2669043

Chennai

Schneider Electric India (P) Ltd.
III Floor, DBS Westminster, No 108/5
Dr. Radhakrishnan Salal, Mylapore
Chennai - 600004
Tel: 44-39143200

Cochin

Schneider Electric India (P) Ltd.
41/408, D1, BeeJay Towers,
Above Qatar Airways, Rajaji Road
Cochin - 682035
Tel: 0484-3048401/2/3
Fax: 0484-3048405

Coimbatore

Schneider Electric India (P) Ltd.
No. 104, 3rd Floor,
Classic Tower, Trichy Road,
Coimbatore - 641013
Tel: 0422-4392729/4392927
Fax: 0422-4392972

Jaipur

Schneider Electric India (P) Ltd.
Jaipur Business Centre 309,
3rd Floor Sangam Tower 190,
Church Road, Jaipur - 302001
Tel: 0141-5118249/5102561
Fax: 0141-5113303

Jamshedpur

Schneider Electric India (P) Ltd.
The Business Centre Moti Bhavan
Road No. 1 Contractor's Area,
Bistupur Jamshedpur - 8311001
Tel: 0657-2224426/2226560
Fax: 0657-2222757

Kolkata

Schneider Electric India (P) Ltd.
Technopolis, 3rd Floor, BP-4, Wing-B,
Sector-V, Salt Lake City, Kolkata - 700091
Tel: 033-33640100-101
Fax: 033-33640102

Lucknow

Schneider Electric India (P) Ltd.
1st Floor, Asha Bhawan 27/II-A
Gokhle Marg, Lucknow - 226001
Tel: 0522-4006010
Fax: 0522-4006011

Ludhiana

Schneider Electric India (P) Ltd.
Office No. 3, 5th Floor, Novelty Plaza
Bhai Walla Chowk, Ludhiana - 140001
Tel: 0161-4656672-75
Fax: 0161-4656671

Mumbai

Schneider Electric India (P) Ltd.
Unit No. 1141, 1142 Building No. 11,
4th Floor, Solitaire Corporate Park
Andheri Kurla Road,
Chakala Andheri (E), Mumbai - 400059
Tel: 022-39404000/40170000
Fax: 022-40170092

Mumbai

Schneider Electric India (P) Ltd.,
2nd Floor, Marwah House,
Kishanlal Marwah Marg,
Off Saki Vihar Road, Marol, Andheri(E),
Mumbai - 400072, Maharashtra.
Tel: 022-30263300. Fax: 022-30263333

Nagpur

Schneider Electric India (P) Ltd.
Fortune Business Centre 6,
Bashant Vihar, W.S.C. Road,
Shankar Nagar, Nagpur - 440010
Tel: 0712-2558581
Fax: 0712-2550070

Pune

Schneider Electric India (P) Ltd.
2nd Floor, R.B. Business Centre
Above Dasa Electronics
Sangvi Nagar, Aundh, Pune - 411007
Tel: 020-39404000/66421900
Fax: 020-66421999

Secunderabad

Schneider Electric India (P) Ltd.
D. No. 1-8-271, # 102,
Ashoka Bhoopal Chambers,
SF. Road, Secunderabad - 500003
Tel: 040-39404000/66330000
Fax: 040-66330000

Vadodara

Schneider Electric India (P) Ltd.
305, "Concorde"
RC Dutt Road, Alkapuri,
Vadodara - 390007
Tel: 0265-2359117/118
Fax: 0265-2353406

Vishakhapatnam

Schneider Electric India (P) Ltd.
Ratnam's Executive Centre
D. No. 10-1-43, 1st Floor
Siripuram Fort, CBM Compound
Vishakhapatnam - 530016
Tel: 0891-2508990
Fax: 0891-2508990



For more information visit our website at: www.schneider-electric.co.in
Schneider Electric India Pvt. Ltd. (A 100% subsidiary of Schneider Electric Industries SAS)
Corporate office : 9th Floor, DLF Building No.10, Tower C, DLF Cyber City, Phase II,
Gurgaon - 122002, Haryana, Tel: 0124 3940400, Fax: 0124 4222036
Customer Care Centre : Toll-free numbers: 1800 180 1707, 1800 103 0011,
General number: 0124 4222040, Email: customercare.in@schneider-electric.com